



Inanç
Cooling system 

soğutmada
kalıcı çözümler

inancteknik.com.tr

MELTON NIGHT CURTAIN



STANDARD FEATURES

- Climate Class: 3M1 / 3M2
- 304 Quality : Wet Board
- Shelf : 4 Lines
- Transparent Price Holders 40 mm
- Thermostat : Automatic Evaporation
- Energy Saving Electronic Fans
- Refrigerant : R290
- Lighting: Canopy, Energy Saving LED Lights
- Night Curtain : With Manual Brake
- With Mirror End Walls / Panoramic End Walls

OPTIONAL FEATURES

- Undershelf LED Lights
- Extra Shelf
- Bumper
- Motorized Night Curtain

CROSS SECTION :

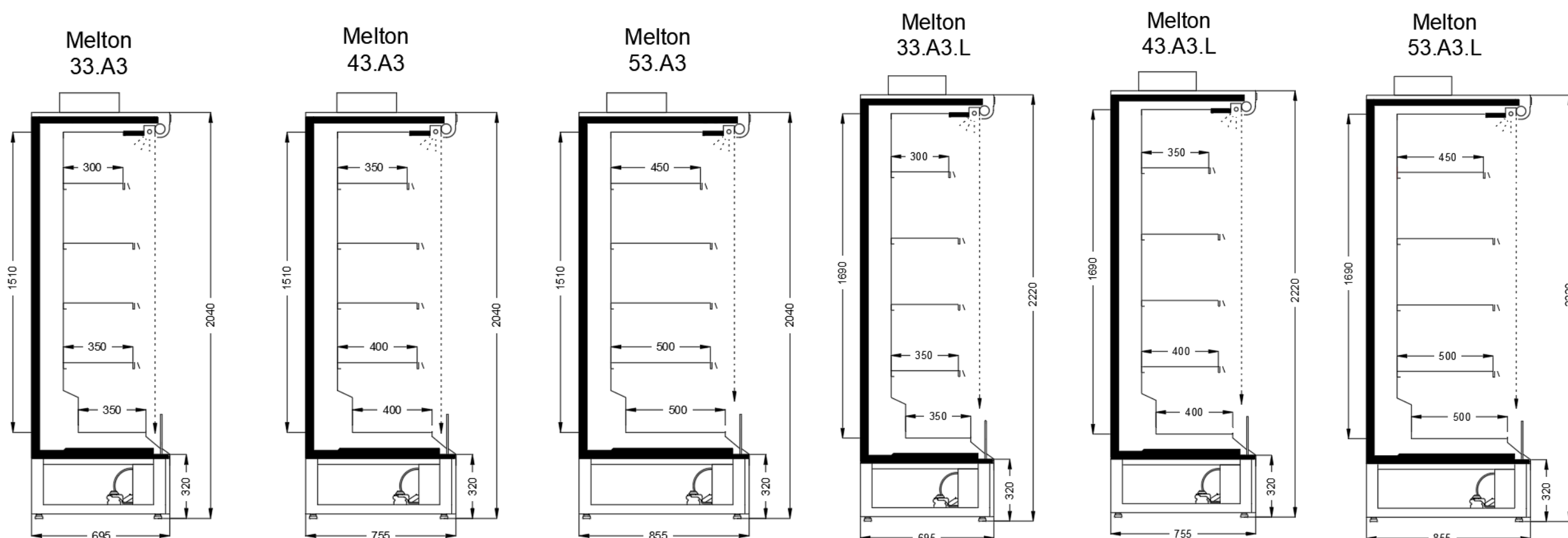



STANDARD FEATURES

- Climate Class: 3M1 / 3M2
- 304 Quality : Wet Board
- Shelf : 4 Lines
- Transparent Price Holders 40 mm
- Thermostat : Automatic Evaporation
- Energy Saving Electronic Fans
- Refrigerant : R290
- Lighting: Vertical in doors frame, Energy Saving LED Lights
- Double Glazed Hinged Doors with Anti-Slam Technology
- With Mirror End Walls / Panoramic End Walls

OPTIONAL FEATURES

- Colored Doors Frame
- Canopy LED Lights
- Undershelf LED Lights
- Extra Shelf
- Bumper

CROSS SECTION :





STANDARD FEATURES

- Climate Class: 3M1 / 3M2
- 304 Quality : Wet Board
- Shelf : 4 Lines
- Transparent Price Holders 40 mm
- Thermostat : Automatic Evaporation
- Energy Saving Electronic Fans
- Refrigerant : R290
- Lighting: Vertical in doors frame, Energy Saving LED Lights
- Double Glazed Frameless Doors with Anti-Slam Technology
- With Mirror End Walls / Panoramic End Walls

OPTIONAL FEATURES

- Canopy LED Lights
- Undershelf LED Lights
- Extra Shelf
- Bumper

CROSS SECTION :

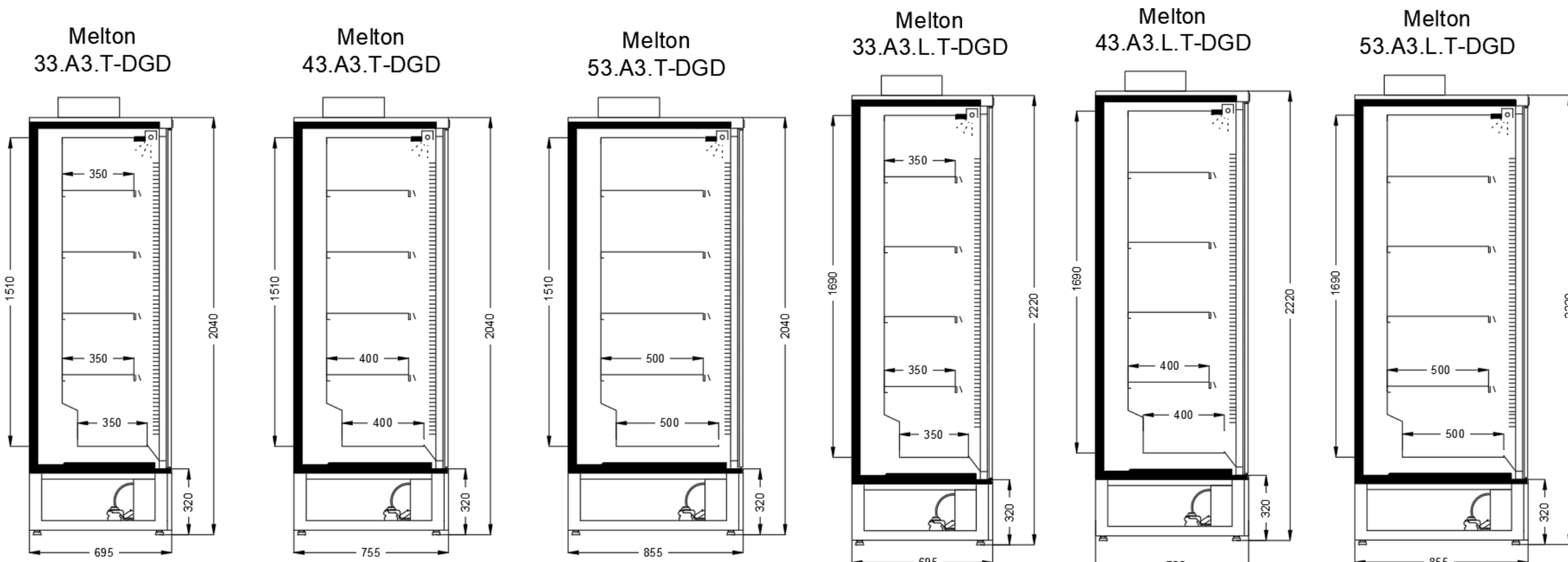

MALABO



STANDARD FEATURES

- Working Temperature: 3L1
- 304 Quality : Wet Board / Suction Plate
- Wire Shelves : 4 Lines in 204 H / 5 Lines in 222 H
- Transparent Price Holders
- Thermostat : Automatic Evaporation
- Energy Saving Electronic Fans
- Hot Gas Defrosting
- Refrigerant : R290
- Lighting: Vertical in doors frame, Energy Saving LED Lights
- Triple Glazed Hinged Doors with Anti-Slam Technology
- Without Mirror End Walls

OPTIONAL FEATURES

- Panoramic End Walls
- Colored Doors Frame
- Extra Shelf
- Bumper

CROSS SECTION :

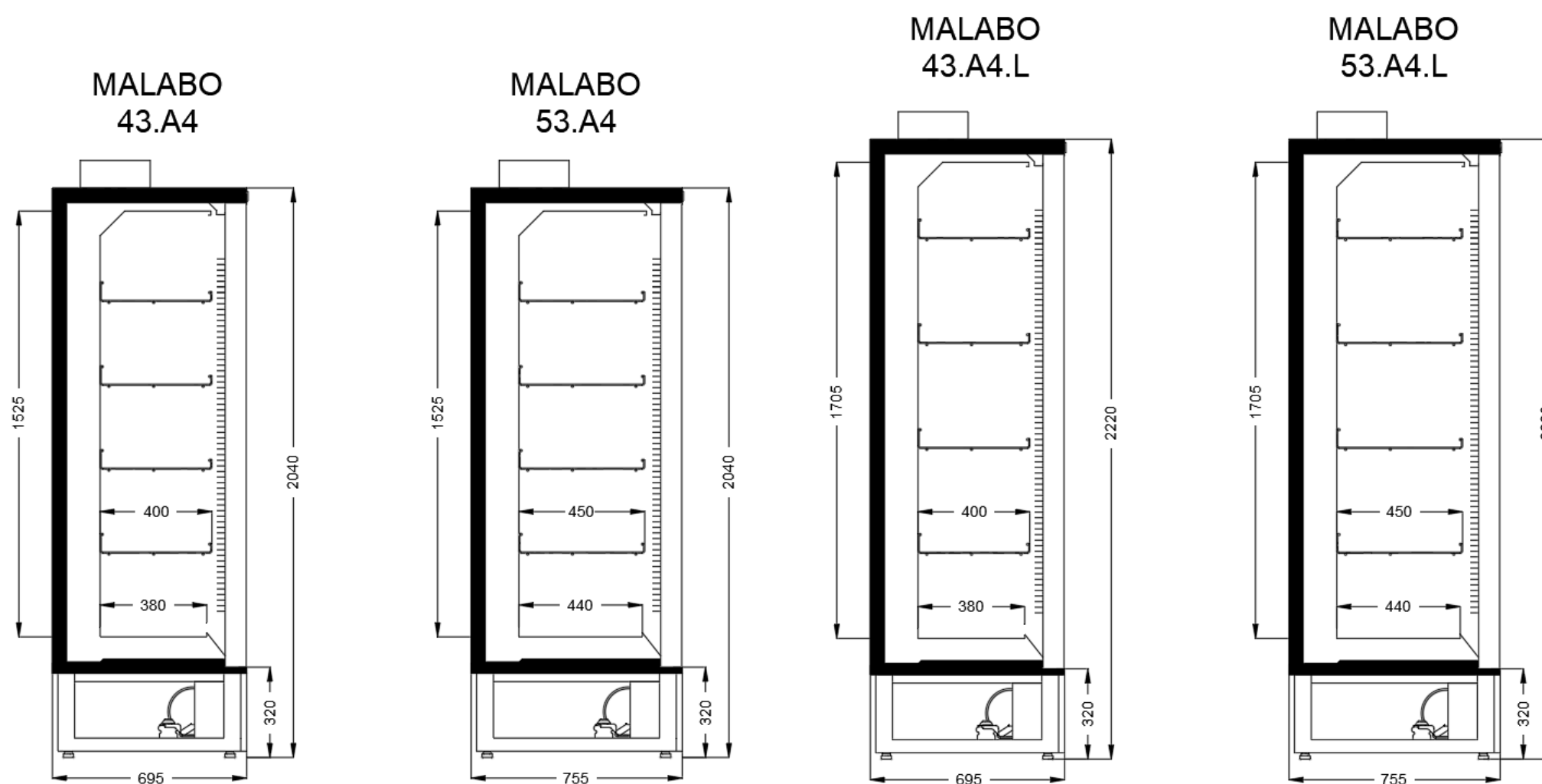

MACON NIGHT CURTAIN



STANDARD FEATURES

- Climate Class: 3M1 / 3M2
- 304 Quality : Wet Board
- Shelf : 2 Lines
- Transparent Price Holders 40 mm
- Thermostat : Automatic Evaporation
- Energy Saving Electronic Fans
- Refrigerant : R290
- Lighting: Canopy, Energy Saving LED Lights
- Night Curtain : With Manual Brake
- With Mirror End Walls / Panoramic End Walls

OPTIONAL FEATURES

- Undershelf LED Lights
- Extra Shelf
- Bumper
- Motorized Night Curtain

CROSS SECTION :

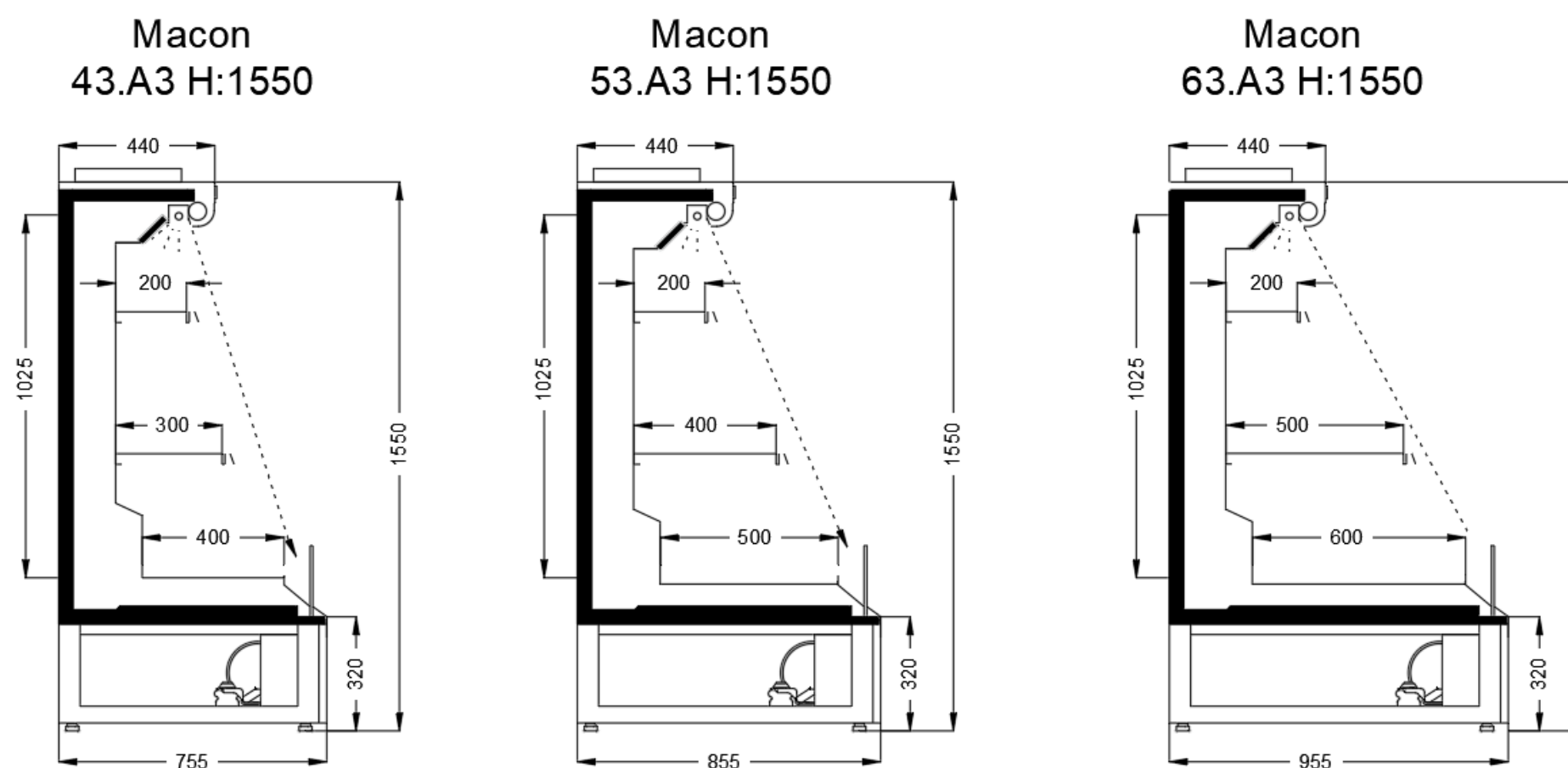

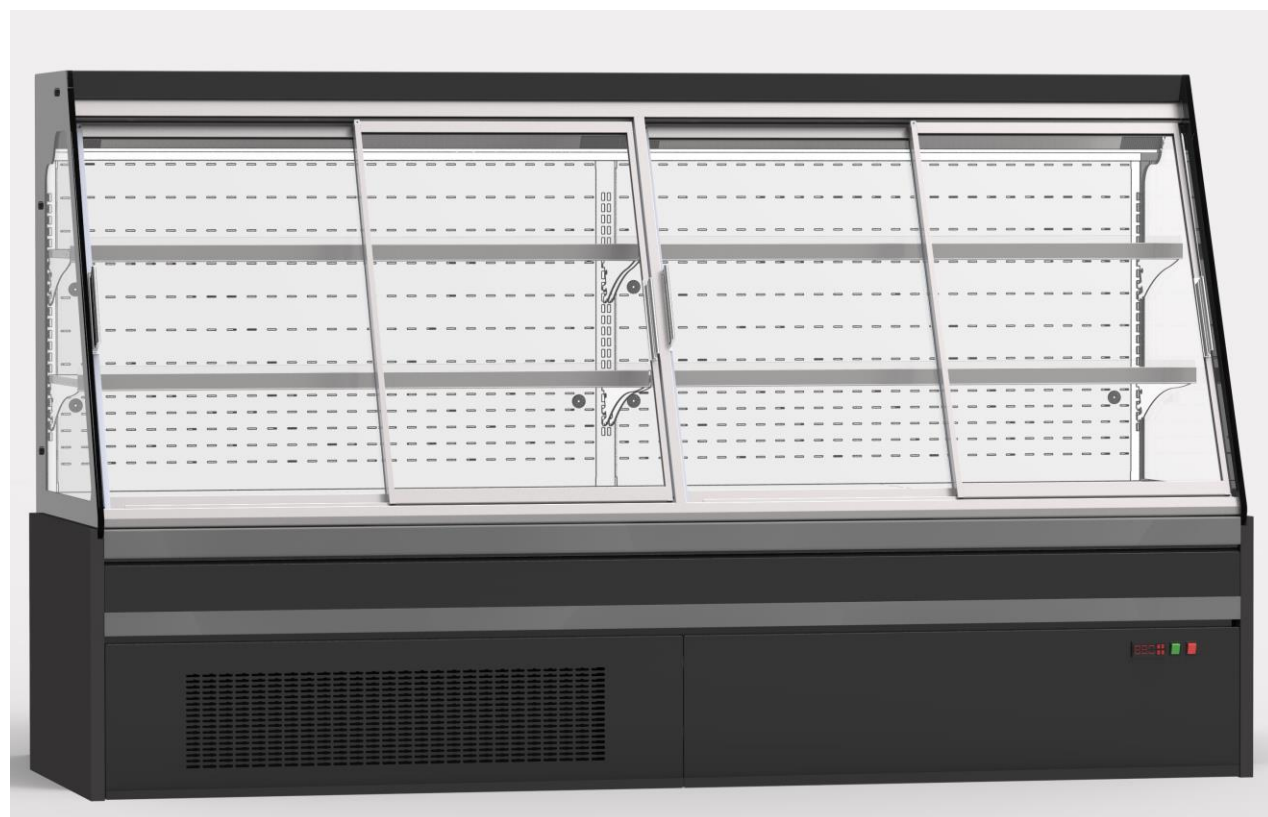

STANDARD FEATURES

- Climate Class: 3M1 / 3M2
- 304 Quality : Wet Board
- Shelf : 2 Lines
- Transparent Price Holders 40 mm
- Thermostat : Automatic Evaporation
- Energy Saving Electronic Fans
- Refrigerant : R290
- Lighting: Canopy, Energy Saving LED Lights
- Double Glazed Sliding Doors
- With Mirror End Walls / Panoramic End Walls

OPTIONAL FEATURES

- Undershelf LED Lights
- Extra Shelf
- Bumper

CROSS SECTION :

**Macon
43.A3.SGD H:1550**

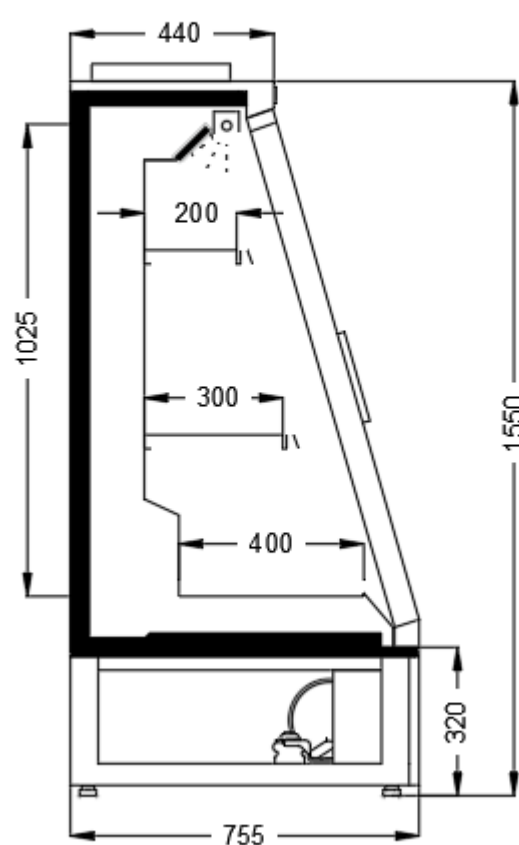

**Macon
53.A3.SGD H:1550**

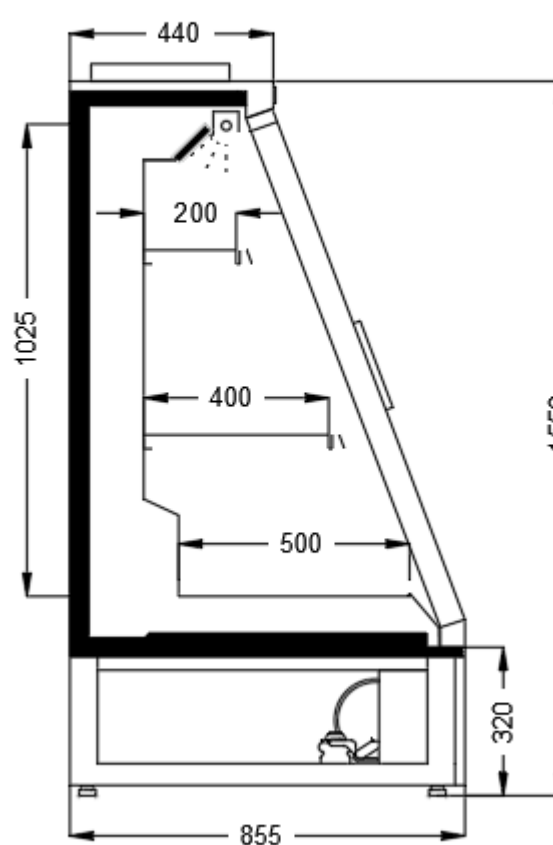

MELBOURNE NIGHT CURTAIN

STANDARD FEATURES

- Climate Class: 3M1 / 3M2
- 304 Quality : Wet Board & Board & Suction Plate
- Shelf : 4 Lines in H 204 / 5 Lines in H 222
- Transparent Price Holders 40 mm
- Thermostat : Automatic Evaporation
- Energy Saving Electronic Fans
- Refrigerant : R444 & R449 & R744
- Lighting: Canopy, Energy Saving LED Lights
- Night Curtain : With Manual Brake
- With Mirror End Walls

OPTIONAL FEATURES

- Panoramic End Walls
- Undershelf LED Lights
- Extra Shelf
- Bumper
- Motorized Night Curtain



CROSS SECTION :

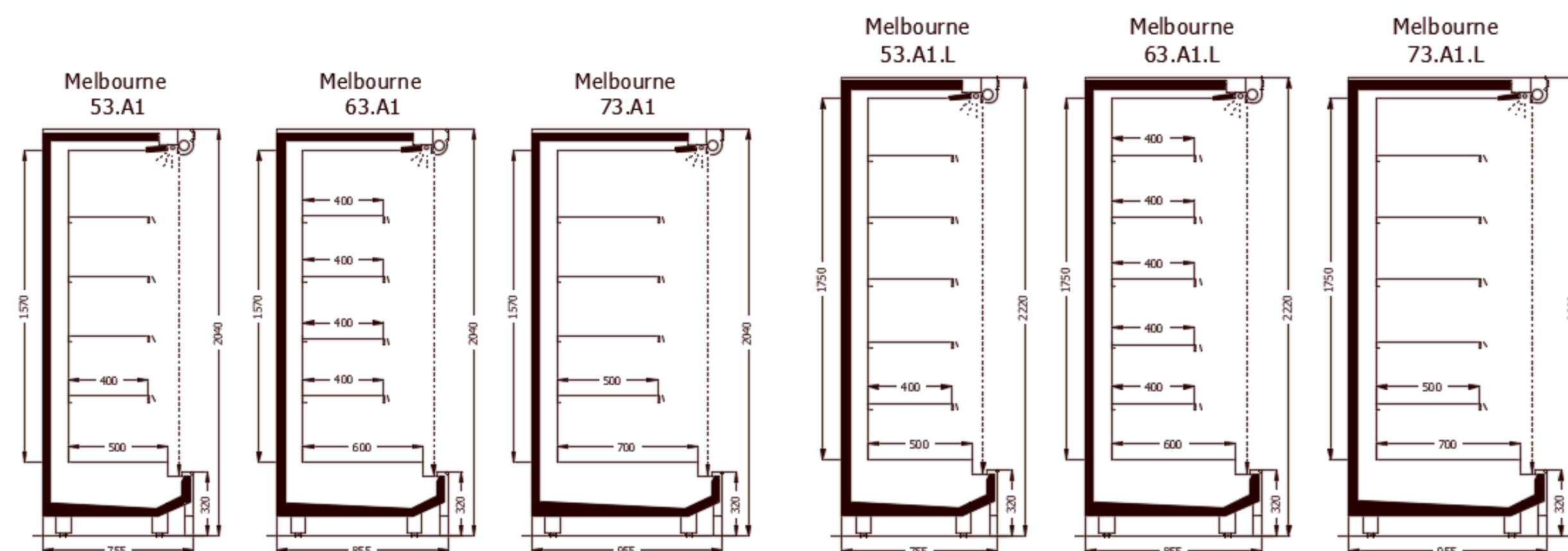



STANDARD FEATURES

- Climate Class: 3M1 / 3M2
- 304 Quality : Wet Board & Board & Suction Plate
- Shelf : 4 Lines in H 204 / 5 Lines in H 222
- Transparent Price Holders 40 mm
- Thermostat : Automatic Evaporation
- Energy Saving Electronic Fans
- Refrigerant : R444 & R449 & R744
- Lighting: Vertical in doors frame, Energy Saving LED Lights
- Double Glazed Hinged Doors with Anti-Slam Technology
- With Mirror End Walls

OPTIONAL FEATURES

- Colored Doors Frame
- Panoramic End Walls
- Canopy LED Lights
- Undershelf LED Lights
- Extra Shelf
- Bumper

CROSS SECTION :

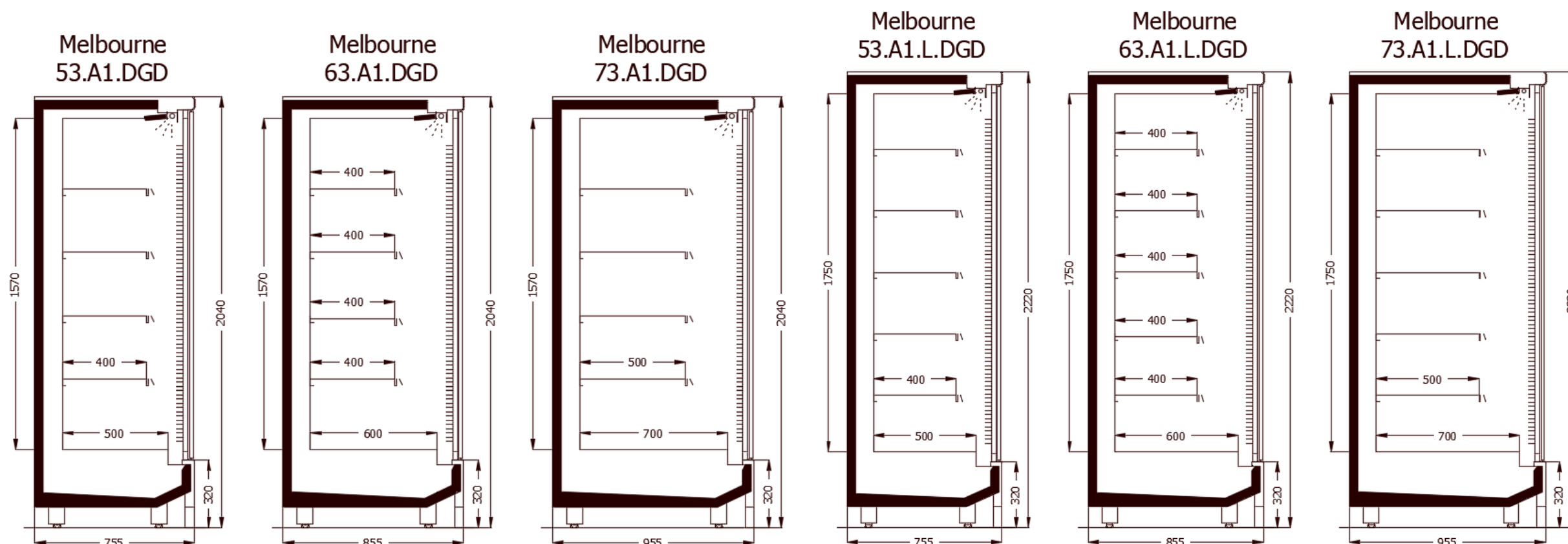

MELBOURNE T-DGD



STANDARD FEATURES

- Climate Class: 3M1 / 3M2
- 304 Quality : Wet Board & Board & Suction Plate
- Shelf : 4 Lines in H 204 / 5 Lines in H 222
- Transparent Price Holders 40 mm
- Thermostat : Automatic Evaporation
- Energy Saving Electronic Fans
- Refrigerant : R444 & R449 & R744
- Lighting: Vertical in doors frame, Energy Saving LED Lights
- Double Glazed Frameless Doors with Anti-Slam Technology
- With Mirror End Walls

OPTIONAL FEATURES

- Panoramic End Walls
- Canopy LED Lights
- Undershelf LED Lights
- Extra Shelf
- Bumper

CROSS SECTION :

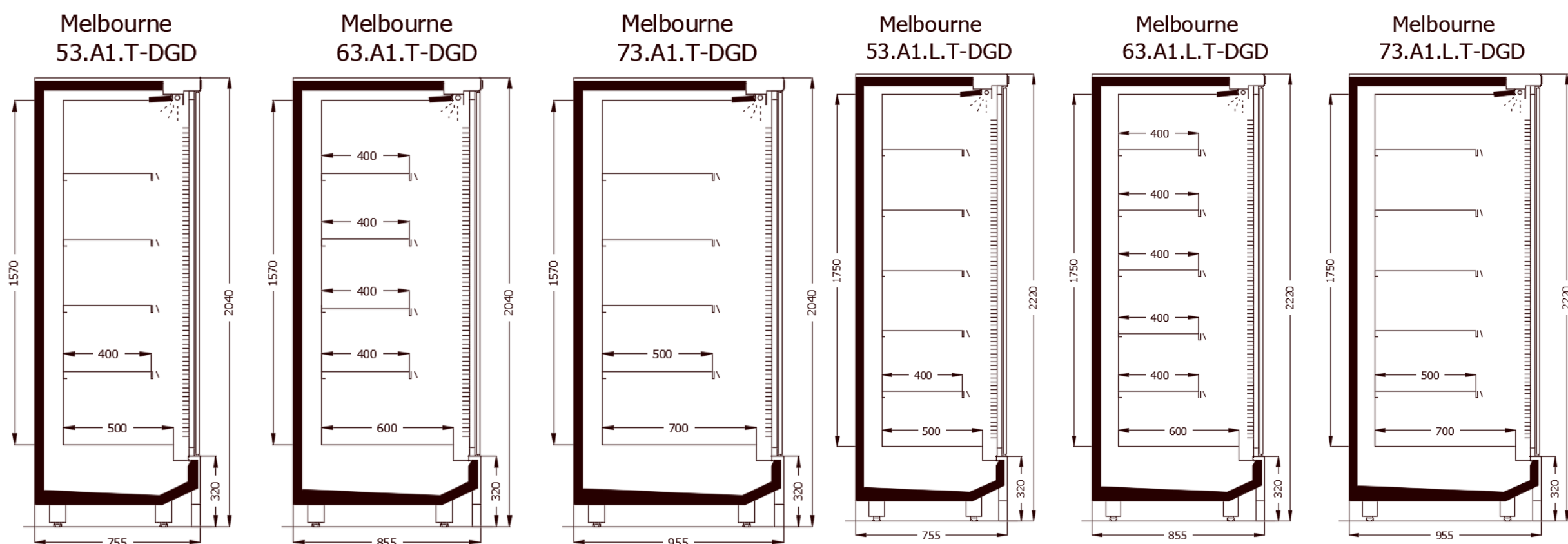

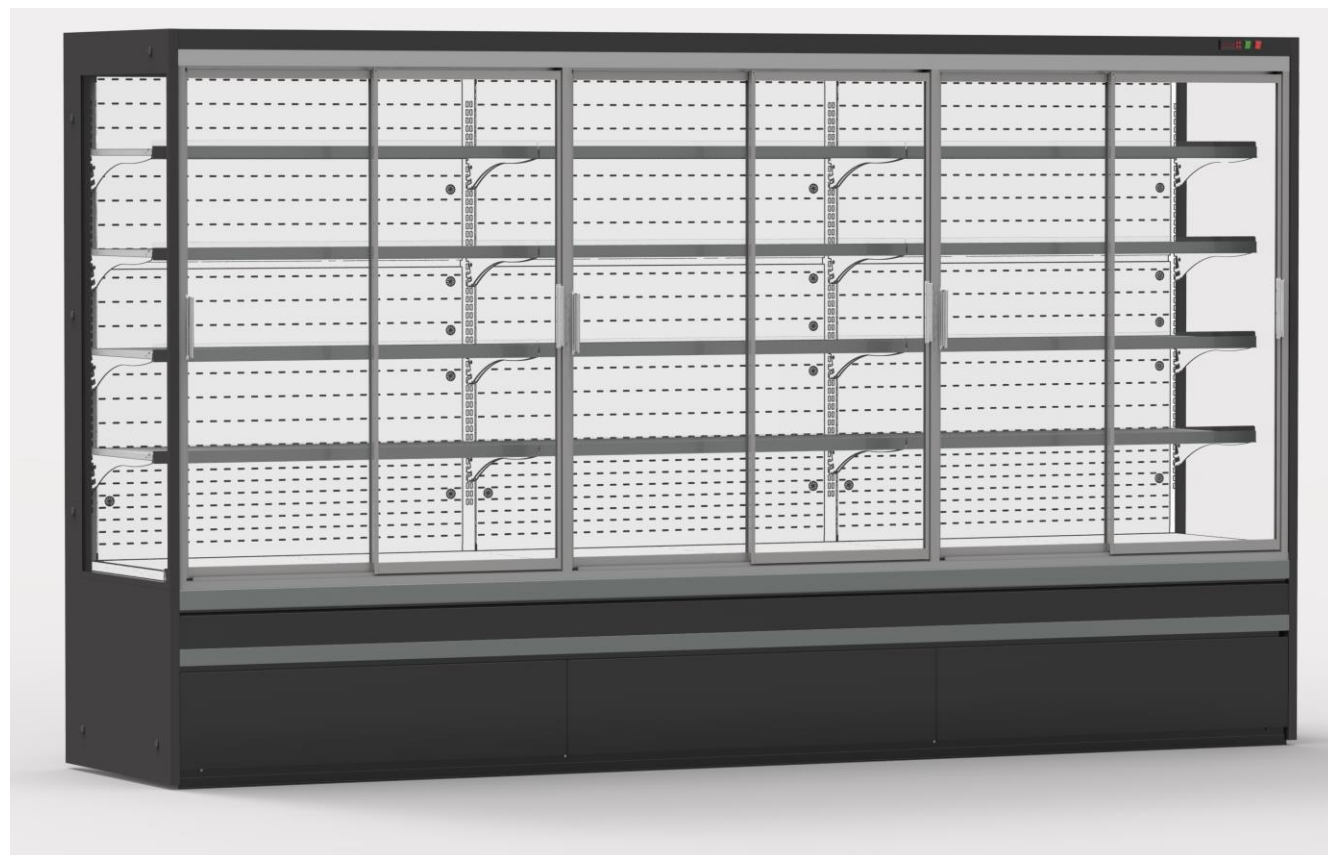

STANDARD FEATURES

- Climate Class: 3M1 / 3M2
- 304 Quality : Wet Board & Board & Suction Plate
- Shelf : 4 Lines in H 204 / 5 Lines in H 222
- Transparent Price Holders 40 mm
- Thermostat : Automatic Evaporation
- Energy Saving Electronic Fans
- Refrigerant : R444 & R449 & R744
- Lighting: Canopy, Energy Saving LED Lights
- Double Glazed Sliding Doors
- With Mirror End Walls

OPTIONAL FEATURES

- Panoramic End Walls
- Frame LED Lights
- Undershelf LED Lights
- Extra Shelf
- Bumper

CROSS SECTION :

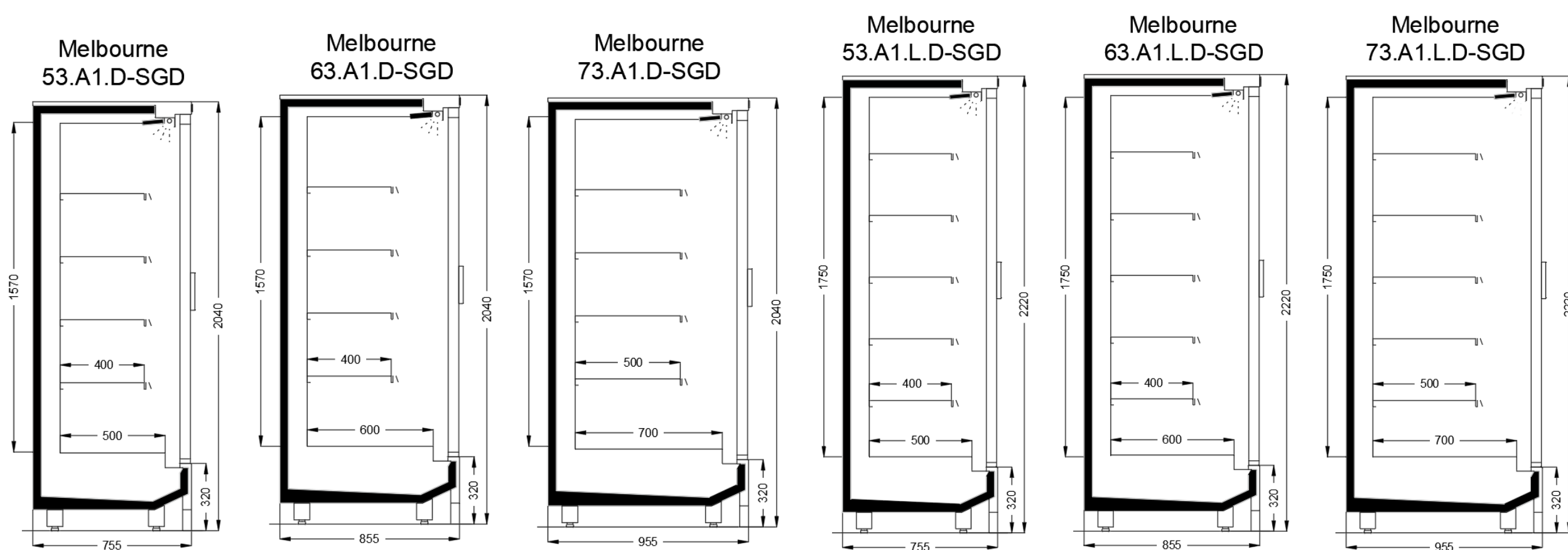

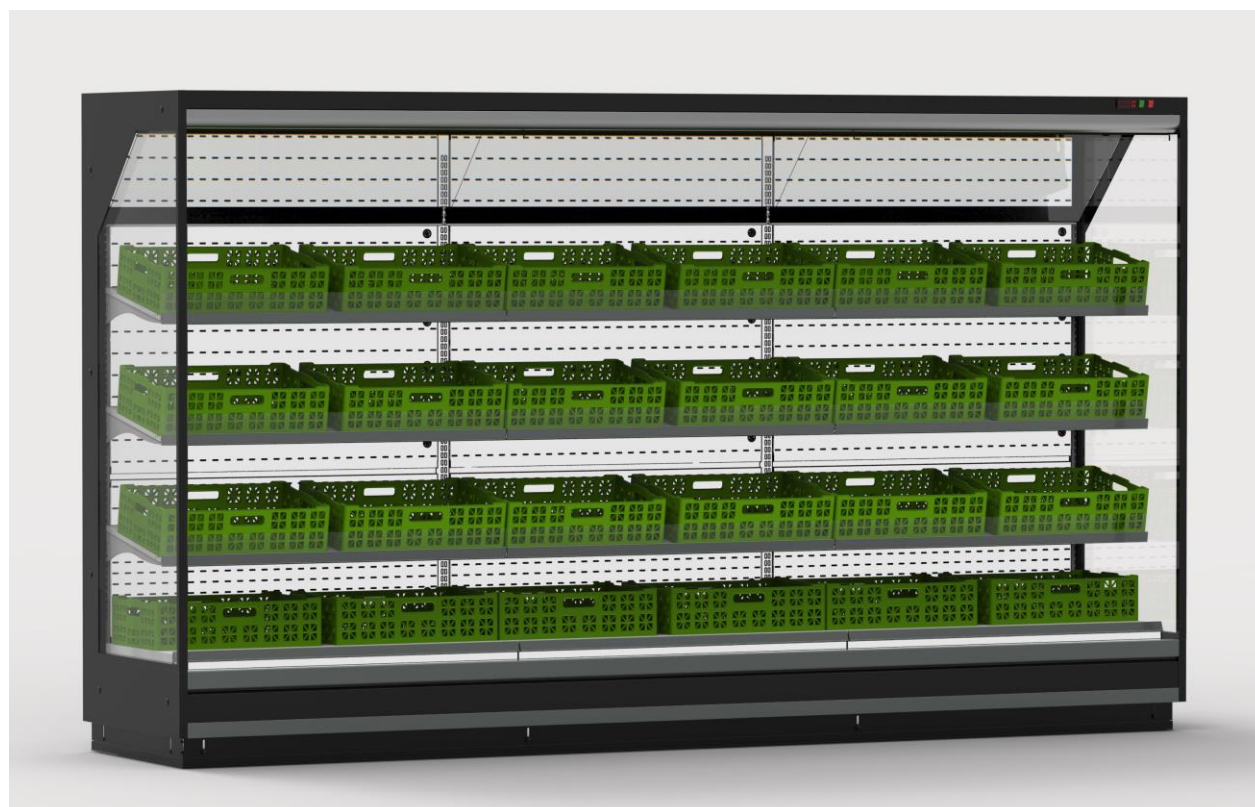

STANDARD FEATURES

- Climate Class: 3M1 / 3M2
- 304 Quality : Wet Board & Board & Suction Plate
- Shelf : 3 Lines in H 204 / 4 Lines in H 222
- Mirror on top
- Transparent Price Holders 40 mm
- Thermostat : Automatic Evaporation
- Energy Saving Electronic Fans
- Refrigerant : R444 & R449 & R744
- Lighting: Canopy, Energy Saving LED Lights
- Night Curtain : With Manual Brake
- With Mirror End Walls

OPTIONAL FEATURES

- Panoramic End Walls
- Underself LED Lights
- Extra Shelf
- Bumper
- Motorized Night Curtain

CROSS SECTION :

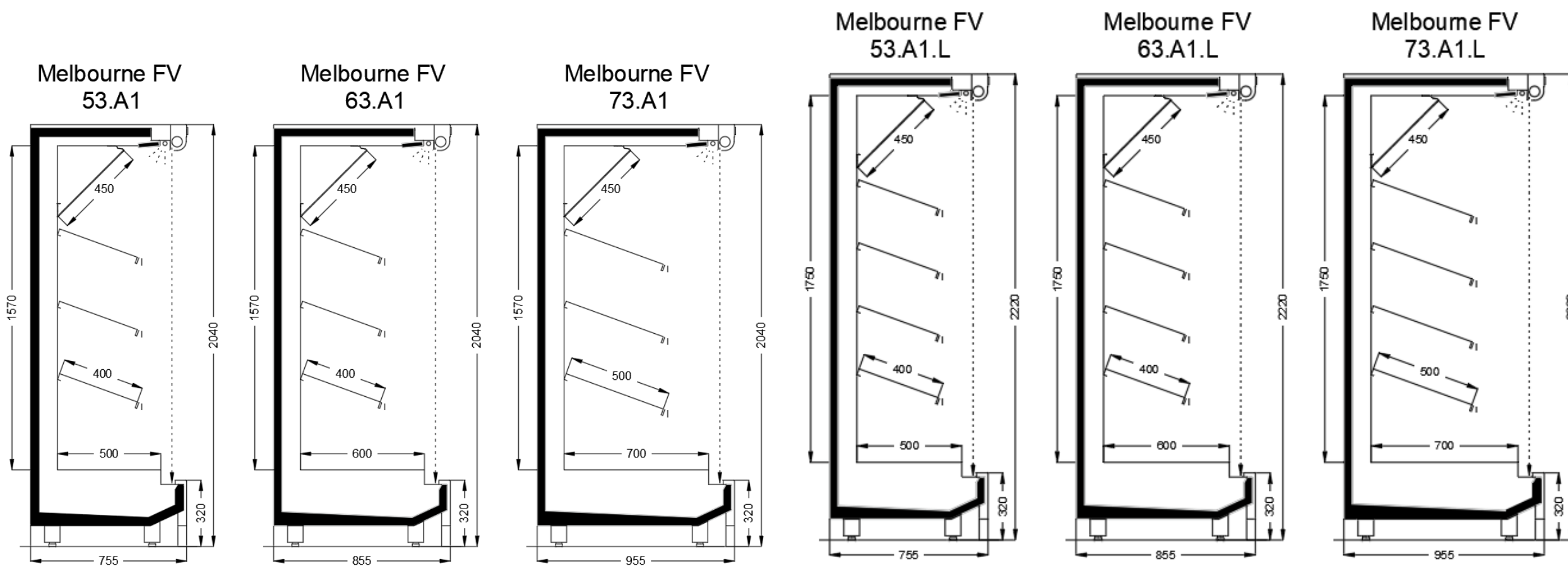

MARBELLA NIGHT CURTAIN

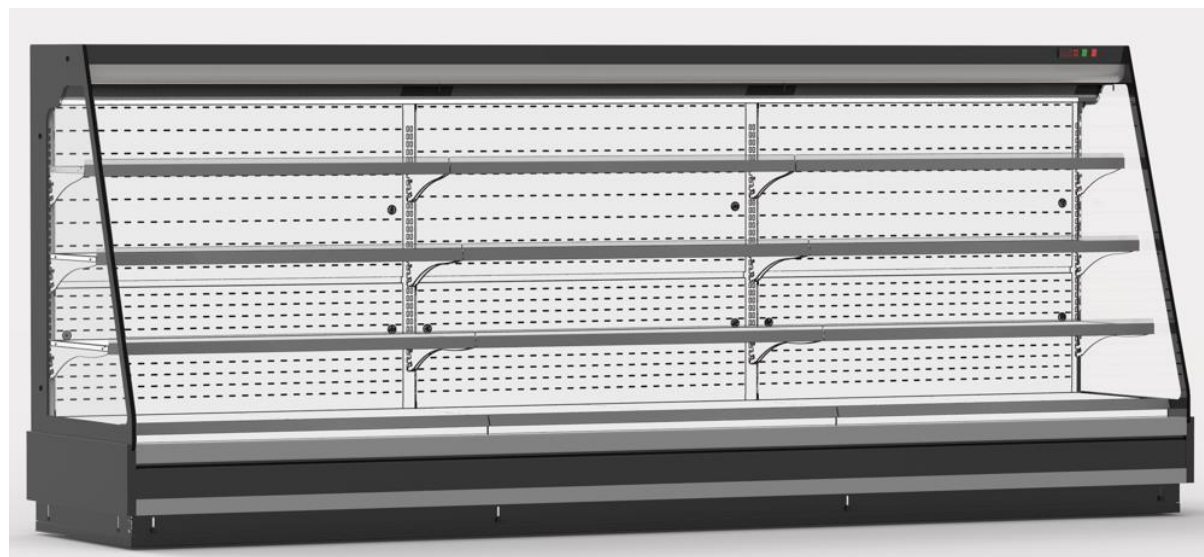

STANDARD FEATURES

- Climate Class: 3M1 / 3M2
- 304 Quality : Wet Board & Board & Suction Plate
- Shelf : 2 Lines
- Transparent Price Holders 40 mm
- Thermostat : Automatic Evaporation
- Energy Saving Electronic Fans
- Refrigerant : R444 & R449 & R744
- Lighting: Canopy, Energy Saving LED Lights
- Night Curtain : With Manual Brake
- With Mirror End Walls / Panoramic End Walls

OPTIONAL FEATURES

- Undershelf LED Lights
- Extra Shelf
- Bumper
- Motorized Night Curtain

CROSS SECTION :

**Marbella
53.A1 H:1550**

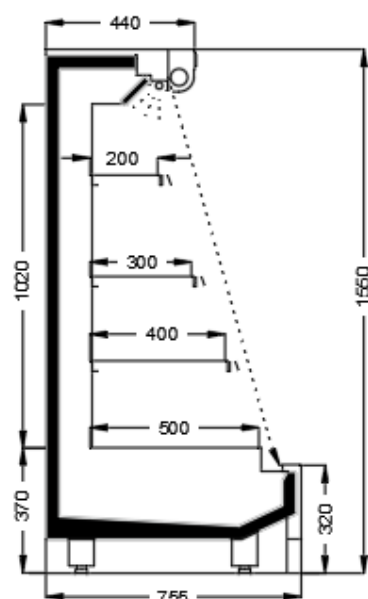

**Marbella
63.A1 H:1550**

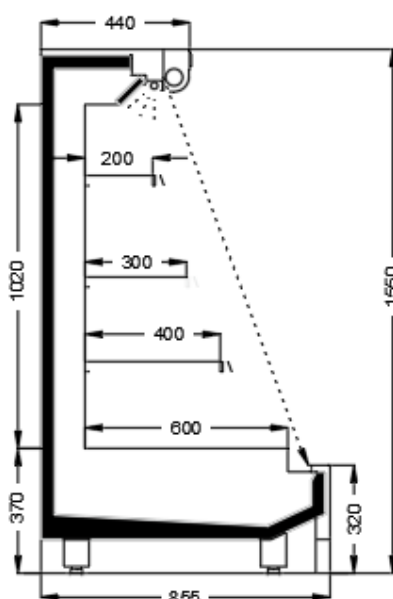

**Marbella
73.A1 H:1550**

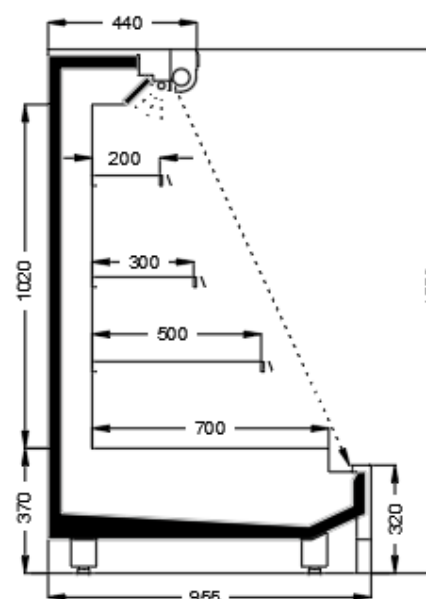

**Marbella
56.A1 H:1550**

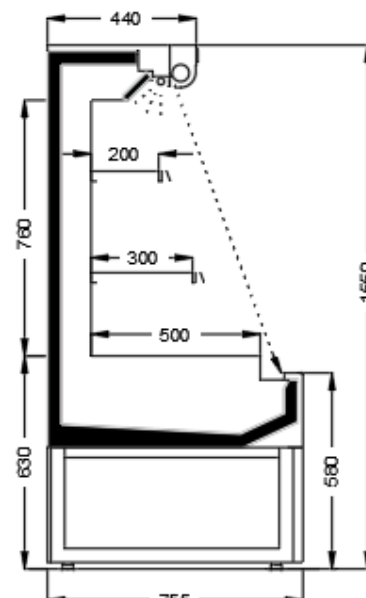

**Marbella
66.A1 H:1550**

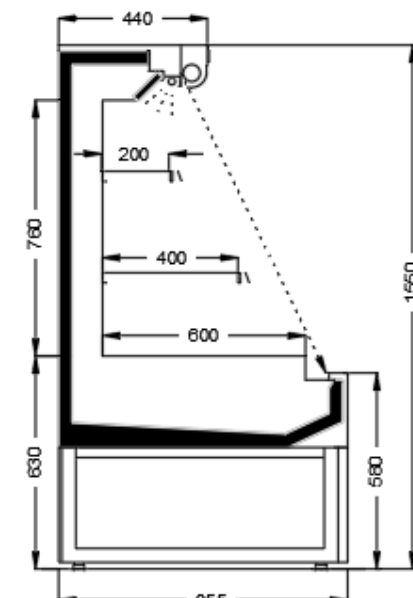

**Marbella
76.A1 H:1550**

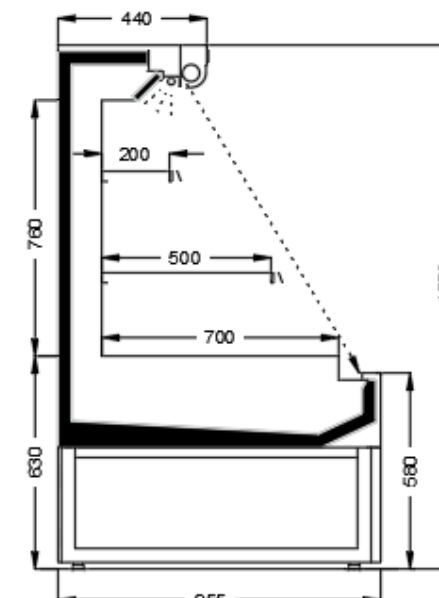



STANDARD FEATURES

- Climate Class: 3M1 / 3M2
- 304 Quality : Wet Board & Board & Suction Plate
- Shelf : 2 Lines
- Transparent Price Holders 40 mm
- Thermostat : Automatic Evaporation
- Energy Saving Electronic Fans
- Refrigerant : R444 & R449 & R744
- Lighting: Canopy, Energy Saving LED Lights
- Double Glazed Sliding Doors
- With Mirror End Walls / Panoramic End Walls

OPTIONAL FEATURES

- Undershelf LED Lights
- Extra Shelf
- Bumper

CROSS SECTION :

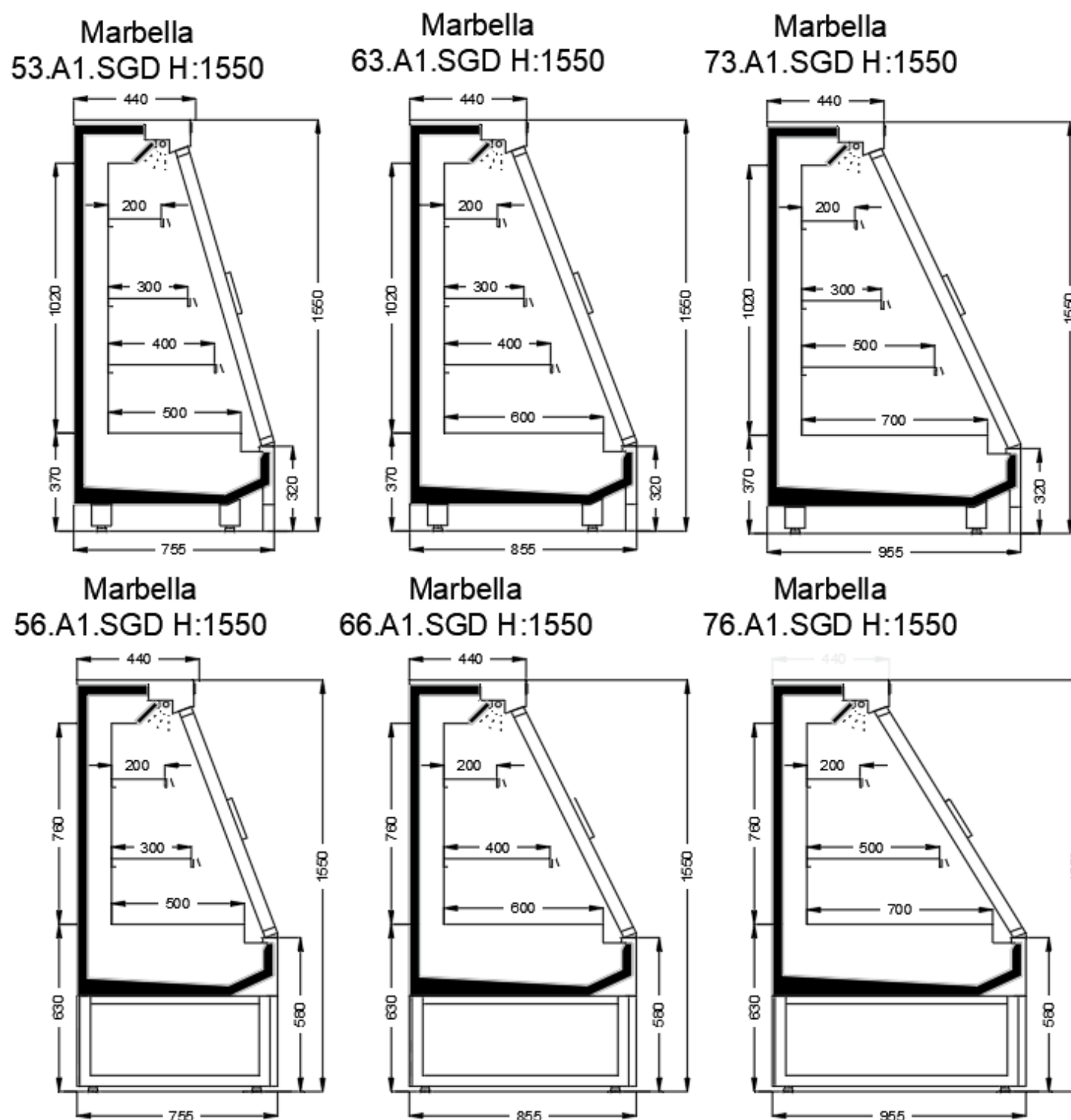

STANDARD FEATURES

- Climate Class: 3L1
- 304 Quality : Wet Board & Suction Plate
- Wire Shelves : 4 Lines in H 204 / 5 Lines in H 222
- Transparent Price Holders 40 mm
- Thermostat : Automatic Evaporation
- Energy Saving Electronic Fans
- Refrigerant : R444 & R449 & R744
- Lighting: Vertical in doors frame, Energy Saving LED Lights
- Triple Glazed Hinged Doors with Anti-Slam Technology
- Without Mirror End Walls

OPTIONAL FEATURES

- Colored Doors Frame
- Panoramic End Walls
- Extra Shelf
- Bumper



CROSS SECTION :

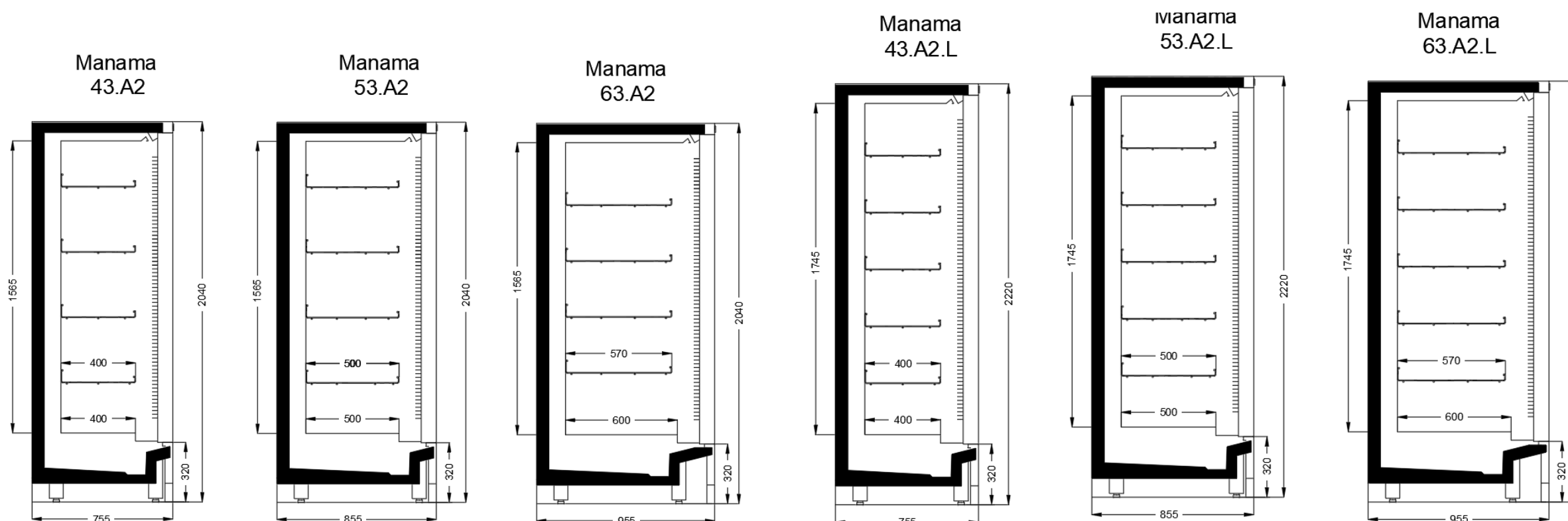

SYDNEY

STANDARD FEATURES

- Climate Class: 3M1 / 3M2
- 304 Quality : Pan & Wet Broad & Suction & Fan Plate
- Energy Saving Electronic Fans
- Thermostat : Automatic Evaporation
- Refrigerant : R444 & R449 & R744
- Lighting: Canopy, Energy Saving LED Lights
- FG : Flat Glass / Cg: Curved Glass

OPTIONAL FEATURES

- Self Service Version
- Bain Marie / Hot Plate Version
- Back Sliding Plexi / Back Sliding Glass Doors
- Unmounted form
- On top of each other loading
- Meat colour LED lights
- Bumper

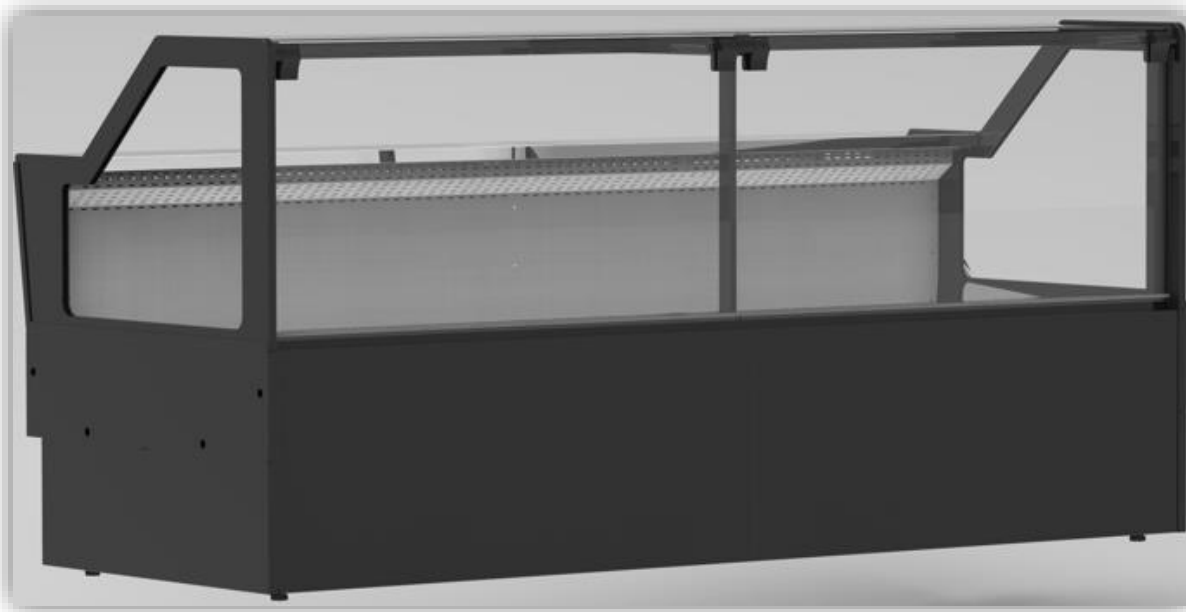

CROSS SECTION :

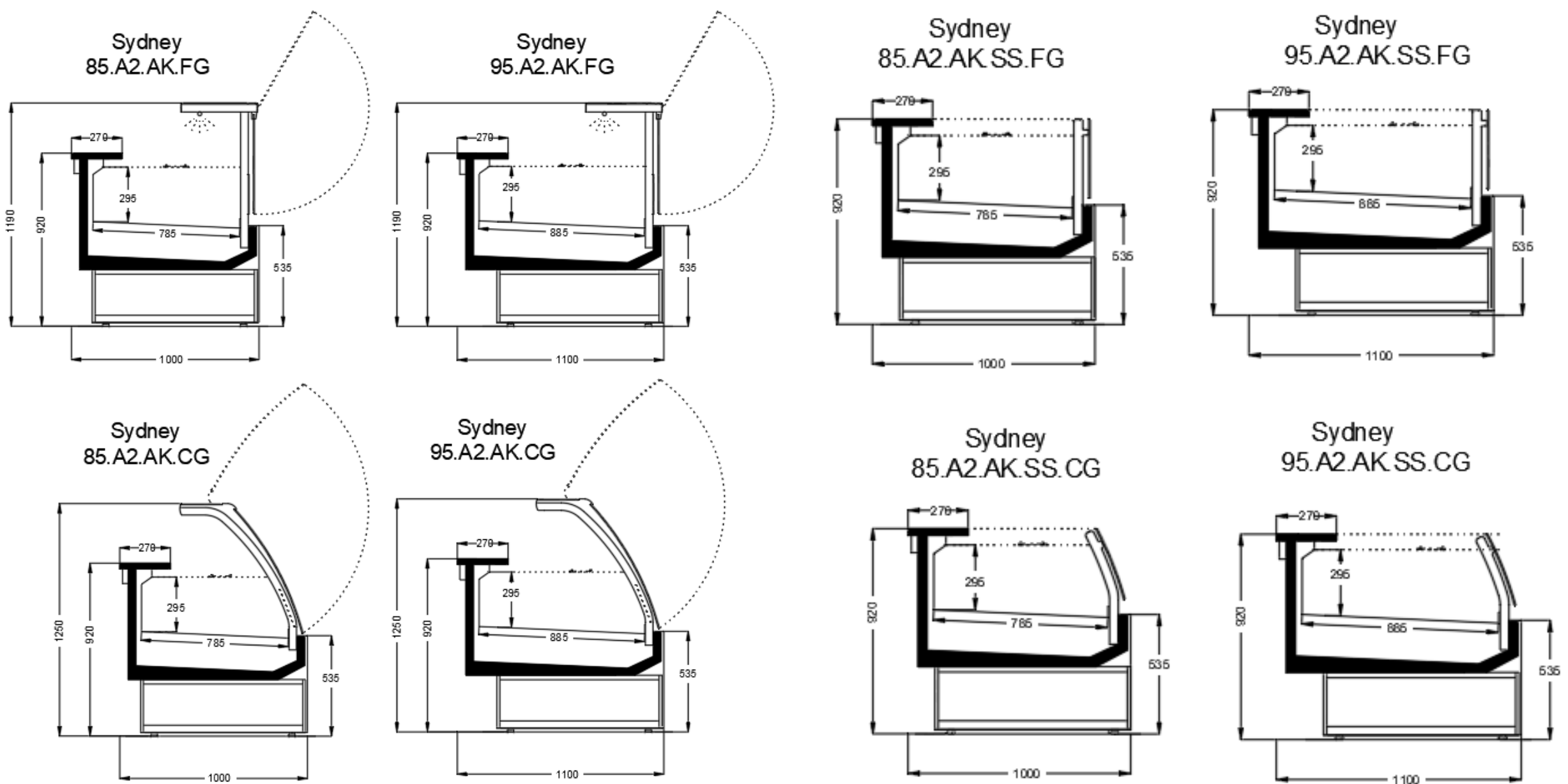

SALTA

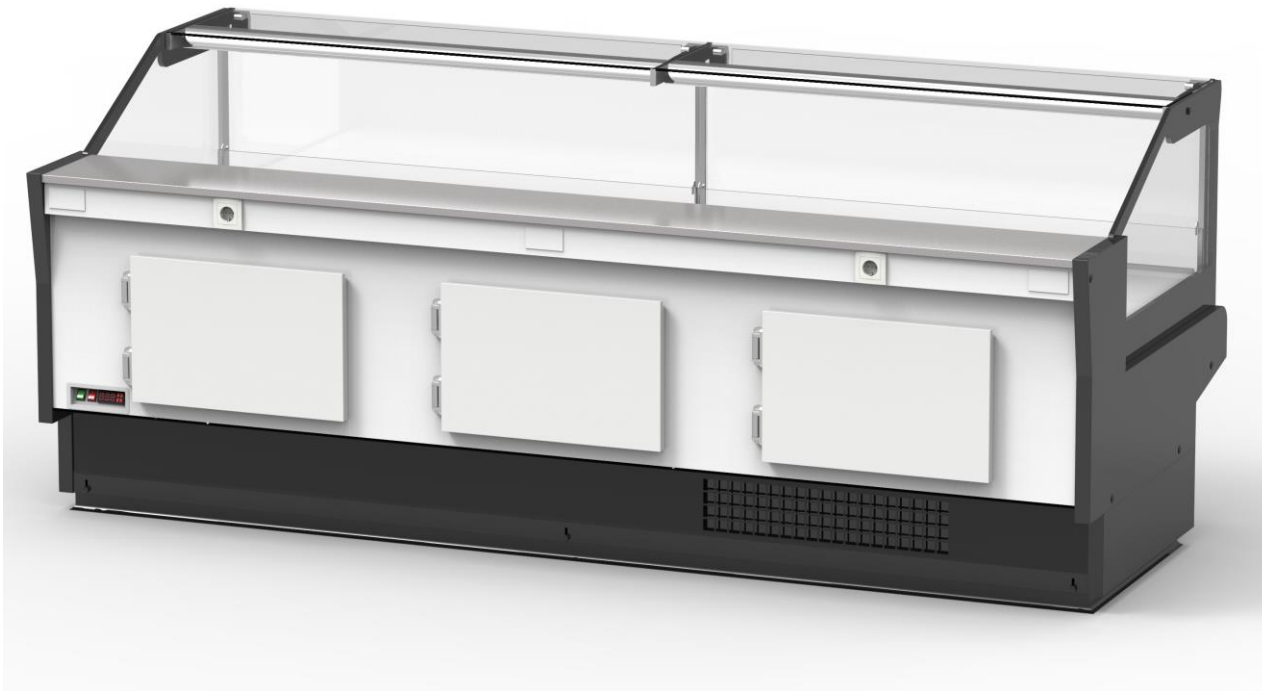

STANDARD FEATURES

- Climate Class: 3M1 / 3M2
- 304 Quality : Pan & Wet Broad & Suction & Fan Plate
- Energy Saving Electronic Fans
- Thermostat : Automatic Evaporation
- Refrigerant : R444 & R449 & R744
- Lighting: Canopy, Energy Saving LED Lights
- FG : Flat Glass / Cg: Curved Glass
- Refrigerated storage

OPTIONAL FEATURES

- Self Service Version
- Back Sliding Plexi / Back Sliding Glass Doors
- Unmounted form
- On top of each other loading
- Meat colour LED lights
- Bumper

CROSS SECTION :

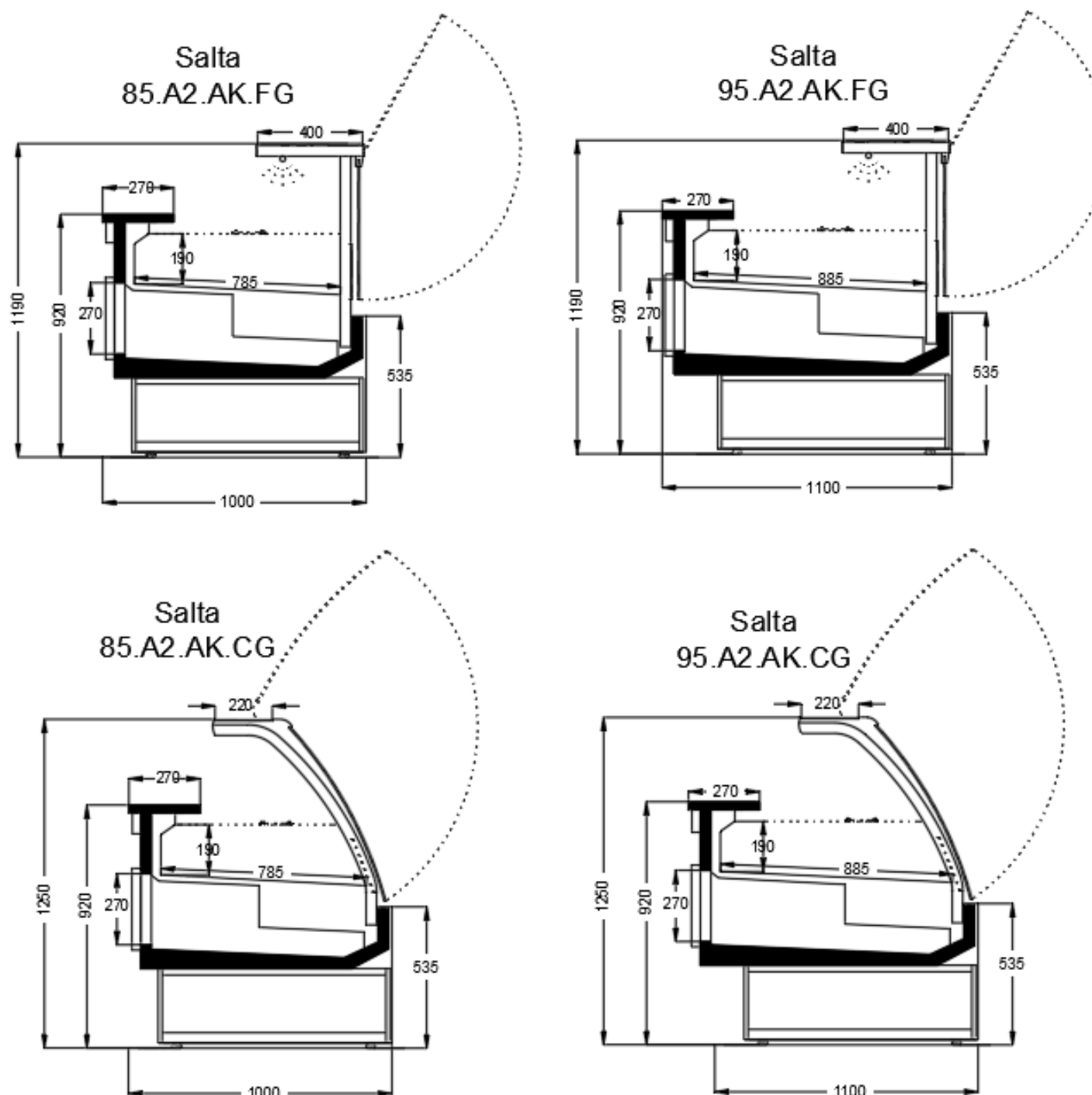

SPARTA

STANDARD FEATURES

- Climate Class: 3M1 / 3M2
- 304 Quality : Pan & Wet Broad & Suction & Fan Plate
- Energy Saving Electronic Fans
- Thermostat : Automatic Evaporation
- Refrigerant : R290
- Lighting: Canopy, Energy Saving LED Lights
- FG : Flat Glass / Cg: Curved Glass

OPTIONAL FEATURES

- Self Service Version
- Fish Version
- Back Sliding Plexi / Back Sliding Glass Doors
- On top of each other loading
- Meat colour LED lights
- Bumper

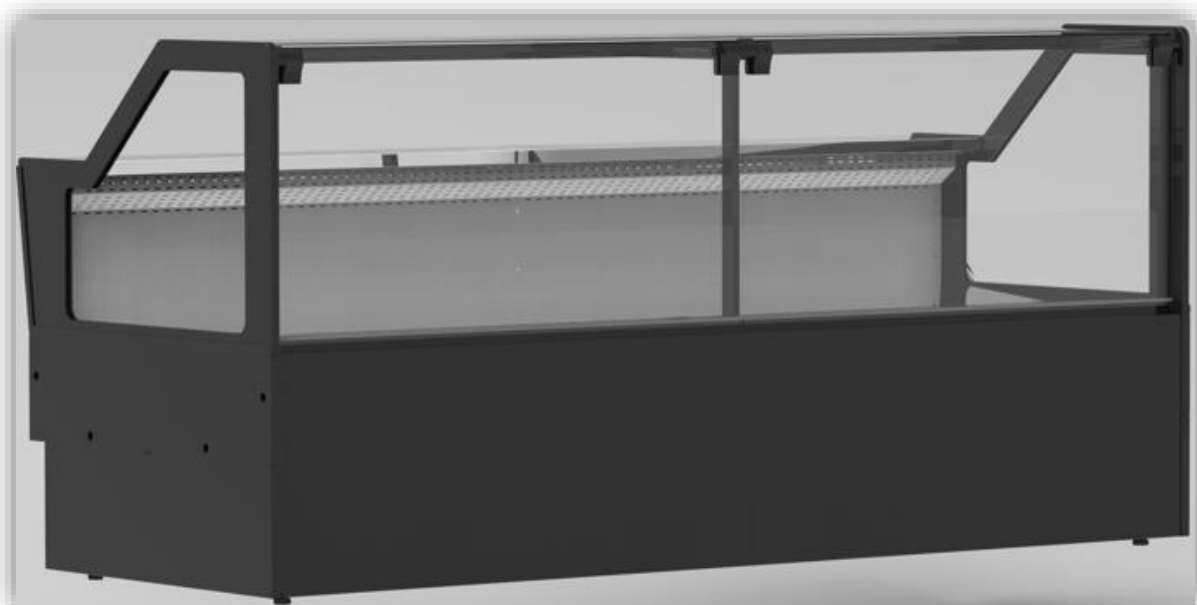

CROSS SECTION :

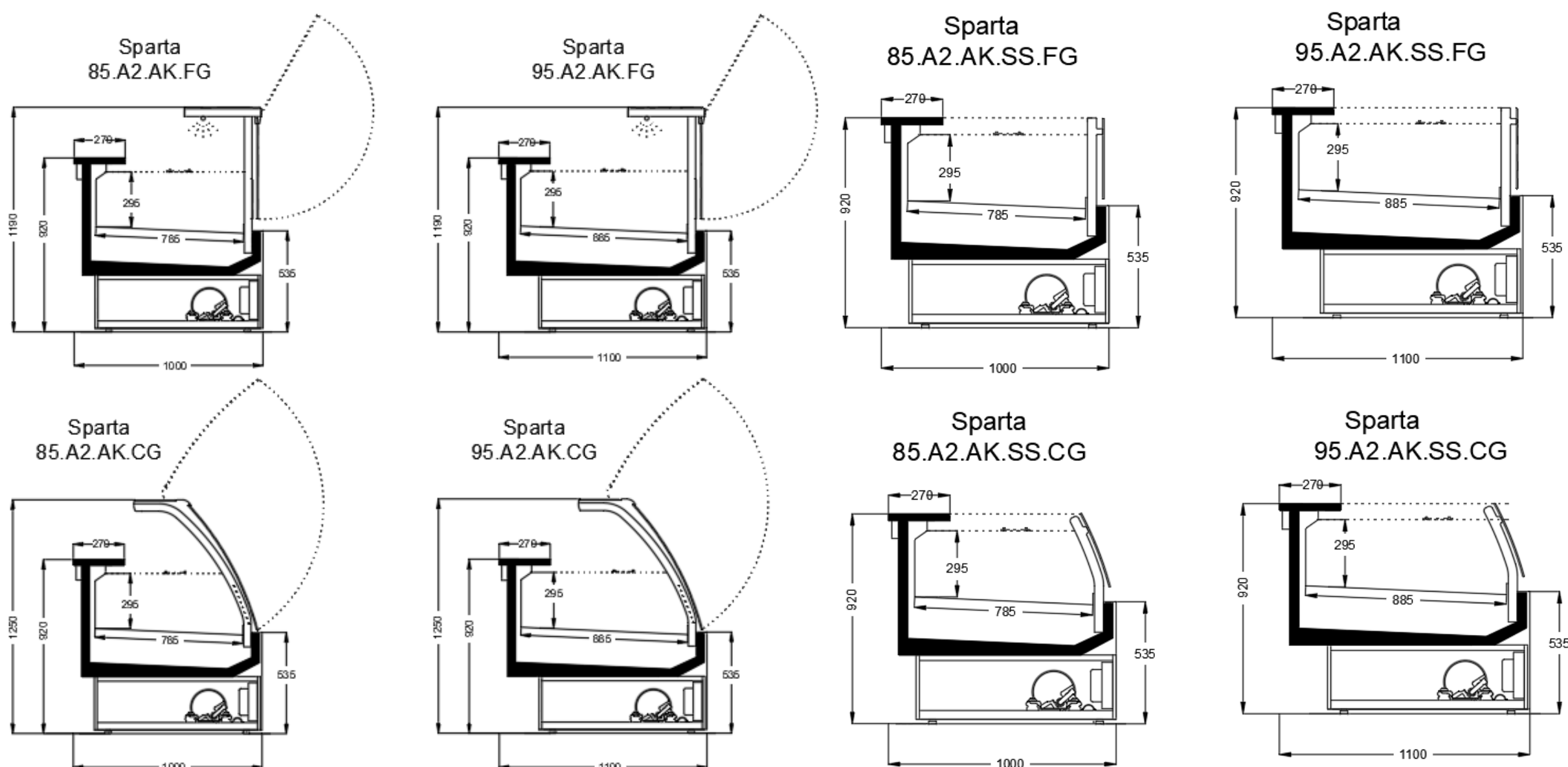

STOW

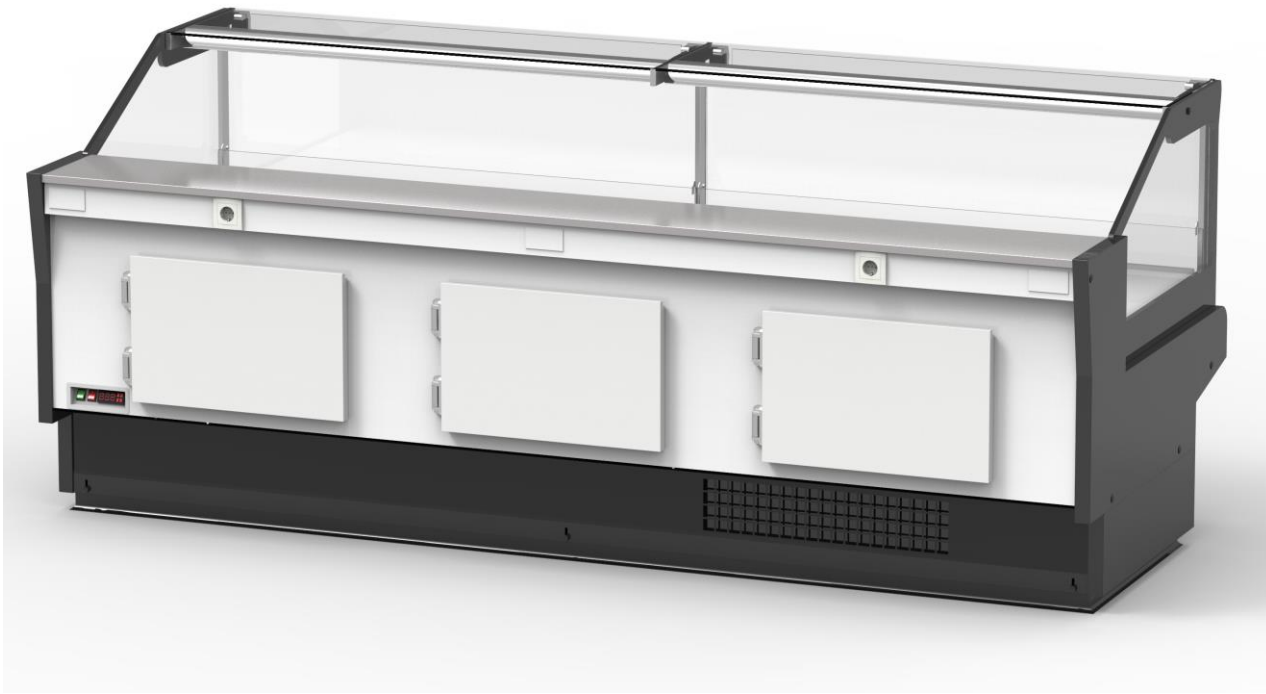

STANDARD FEATURES

- Climate Class: 3M1 / 3M2
- 304 Quality : Pan & Wet Broad & Suction & Fan Plate
- Energy Saving Electronic Fans
- Thermostat : Automatic Evaporation
- Refrigerant : R290
- Lighting: Canopy, Energy Saving LED Lights
- FG : Flat Glass / Cg: Curved Glass
- Refrigerated storage

OPTIONAL FEATURES

- Back Sliding Plexi / Back Sliding Glass Doors
- On top of each other loading
- Meat colour LED lights
- Bumper

CROSS SECTION :

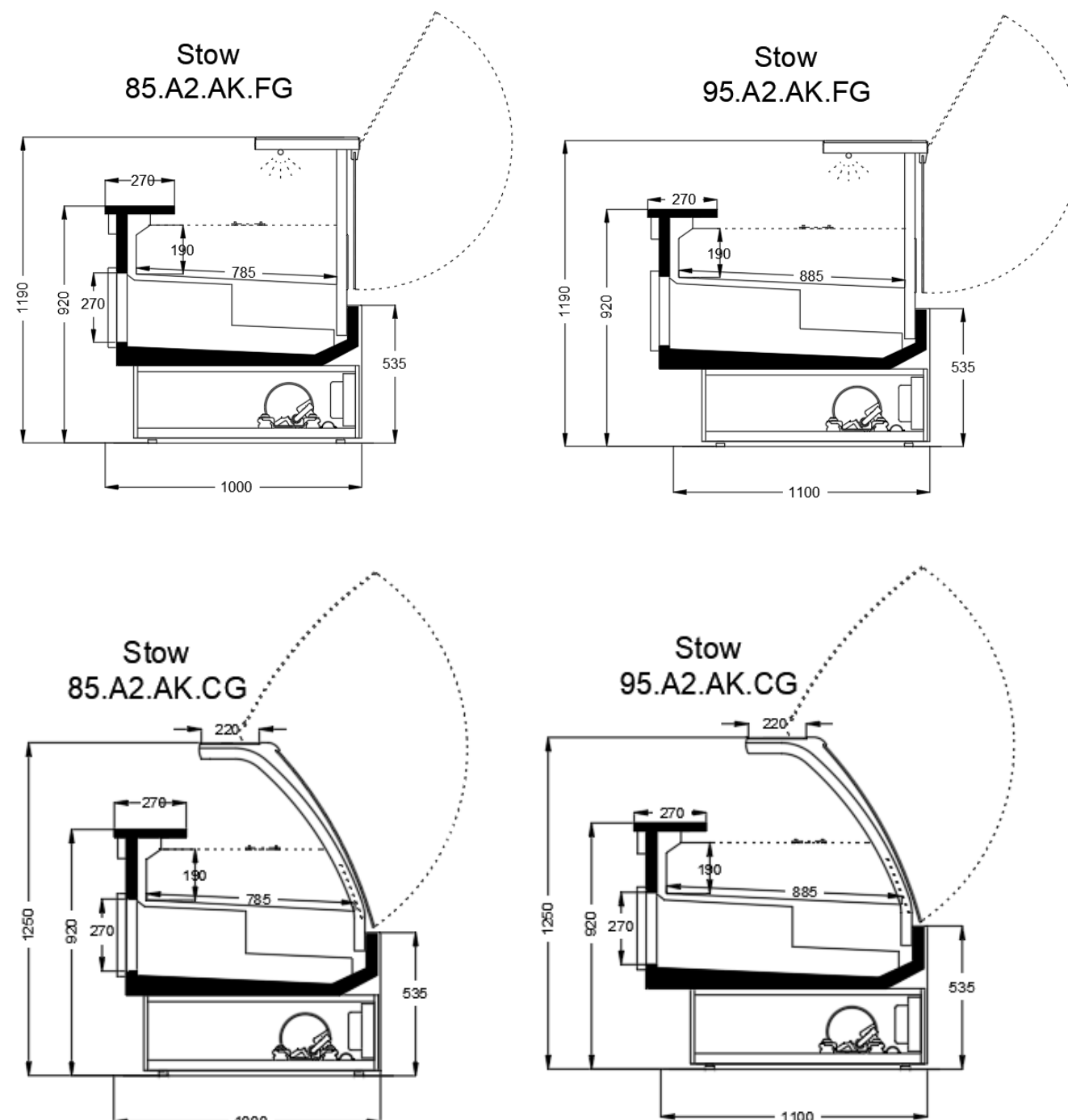



STANDARD FEATURES

- Climate Class: 3M1 / 3M2
- Energy Saving Electronic Fans
- Thermostat : Automatic Evaporation
- Refrigerant : R290
- Automatic Water Evaporation

OPTIONAL FEATURES

- Sliding Doors
- Night Curtain
- Bumper

CROSS SECTION :

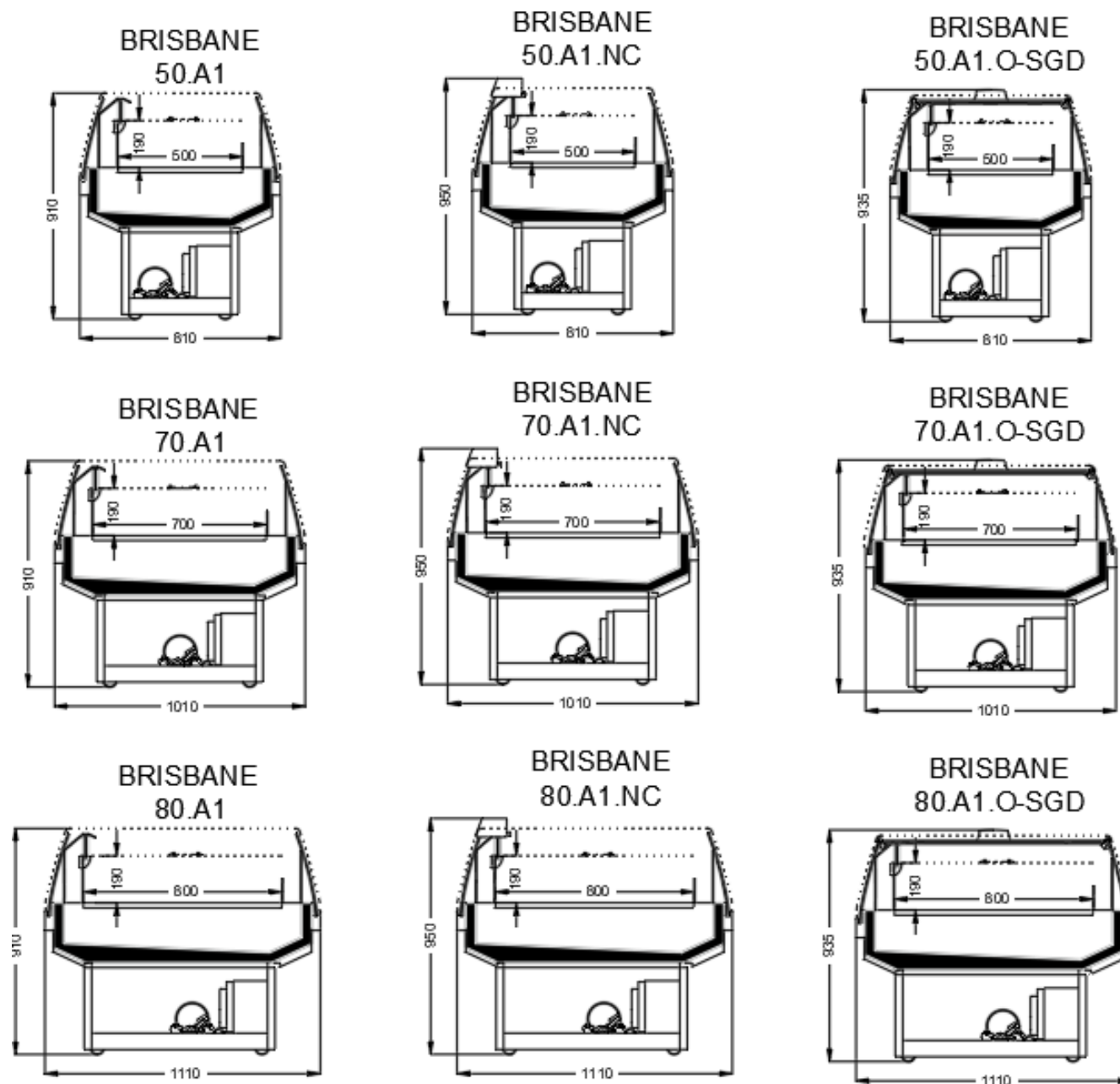

HAVANA

STANDARD FEATURES

- Climate Class: 3L1
- 304 Quality : Wet Board
- Thermostat : Automatic Evaporation
- Energy Saving Electronic Fans
- Refrigerant : R290
- Automatic Water Evaporation

OPTIONAL FEATURES

- Push-Back / Sliding Doors
- Wire Divider
- Bumper



CROSS SECTION :

Havana
85.A1

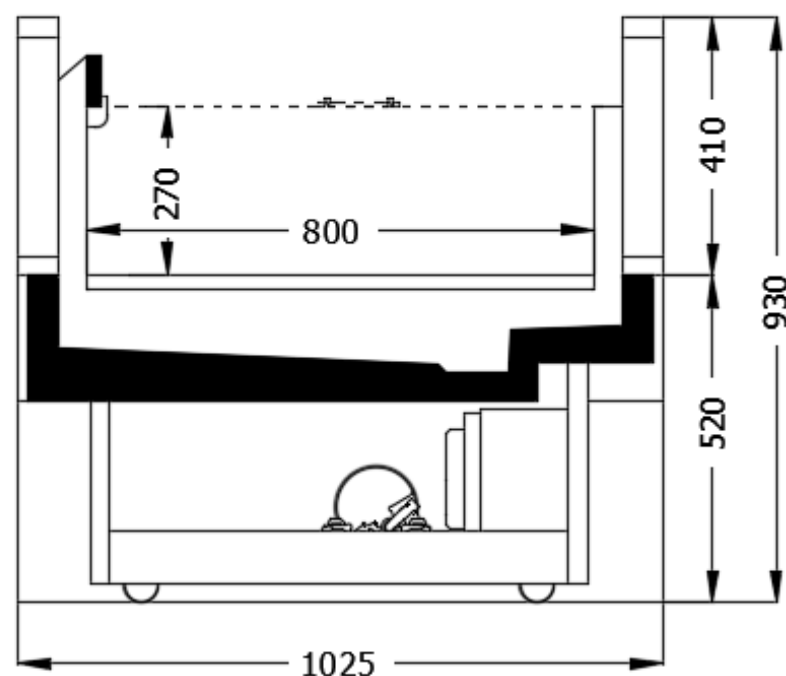

Havana
85.A1.SGD

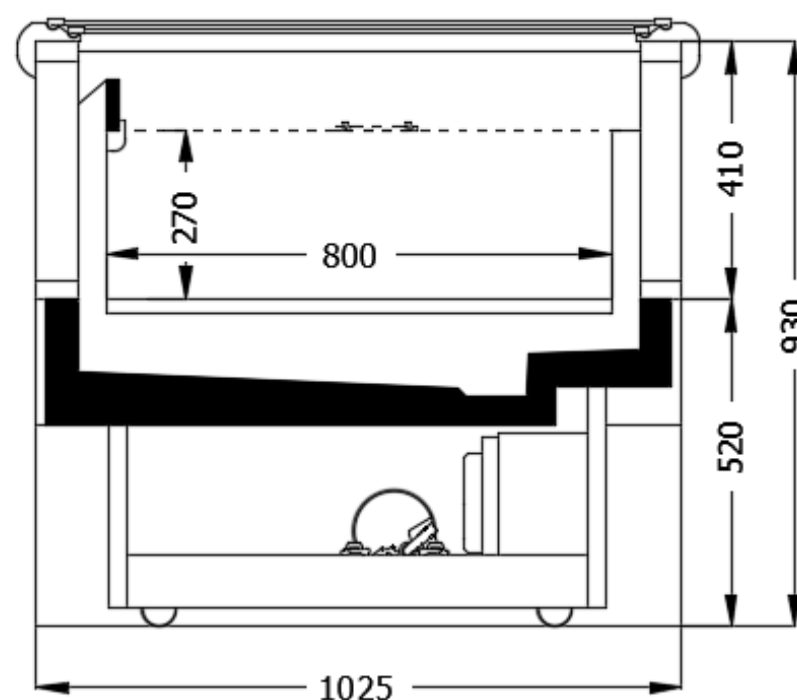



STANDARD FEATURES

- Climate Class: 3L1
- 304 Quality : Wet Broad
- Energy Saving Electronic Fans
- Thermostat : Automatic Evaporation
- Refrigerant : R444 & R449 & R744

OPTIONAL FEATURES

- Push-Back / Sliding Doors
- Bumper
- Wire Divider
- Superstructure

CROSS SECTION :

Hanna
83.A1

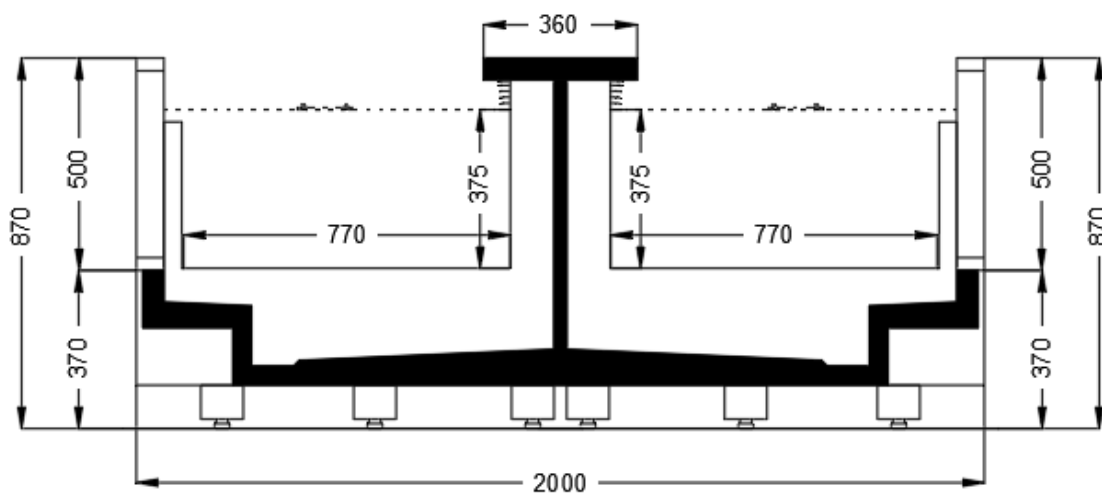

Hanna
83.A1.SGD

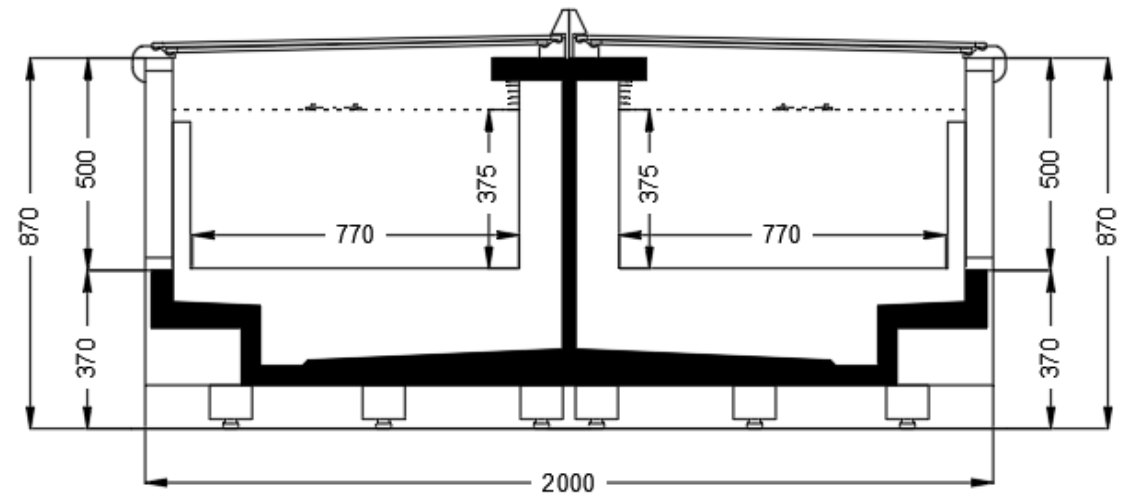

HARTUM

STANDARD FEATURES

- Climate Class: 3L1
- 304 Quality : Wet Broad
- Energy Saving Electronic Fans
- Thermostat : Automatic Evaporation
- Refrigerant : R444 & R449 & R744

OPTIONAL FEATURES

- Head unit for island
- Push-Back / Sliding Doors
- Bumper
- Wire Divider
- Superstructure

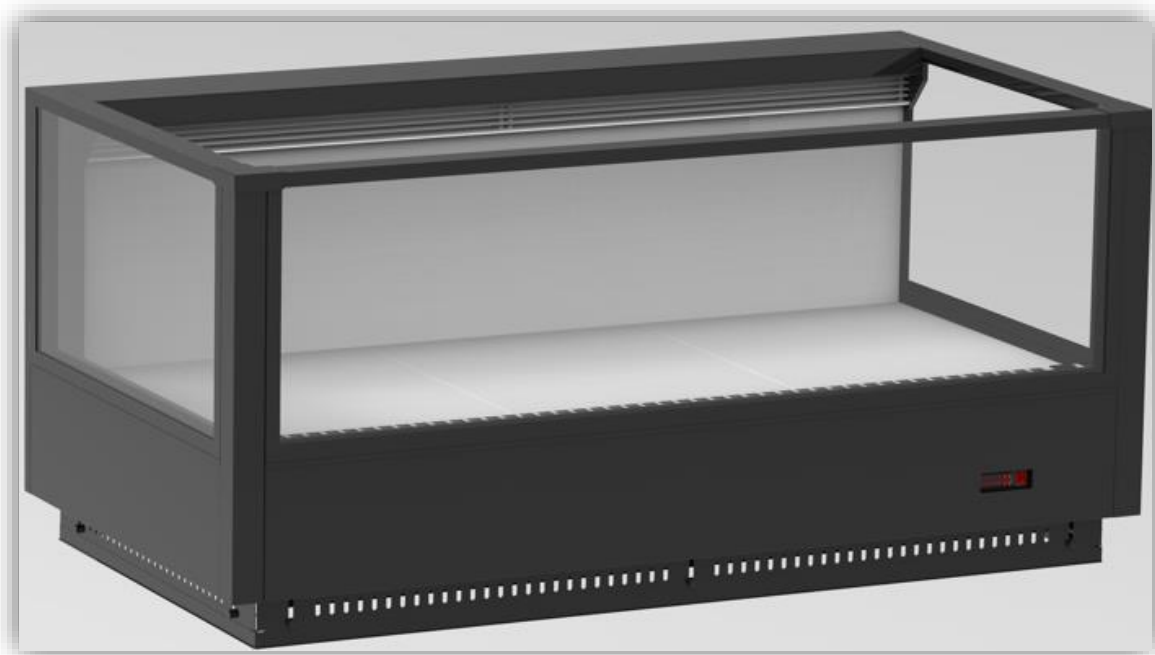

CROSS SECTION :

Hartum
83.A1

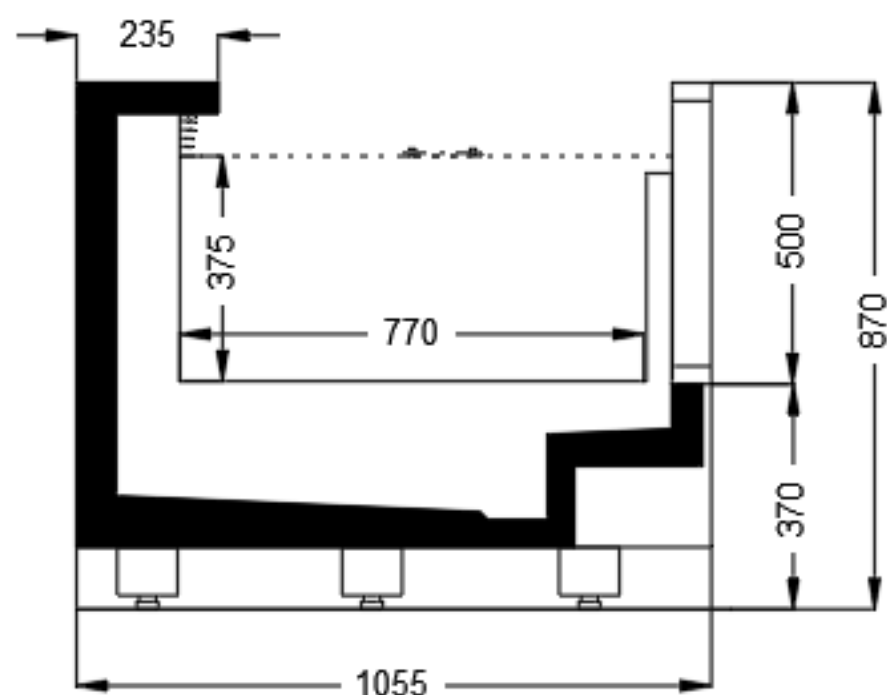

Hartum
83.A1.SGD

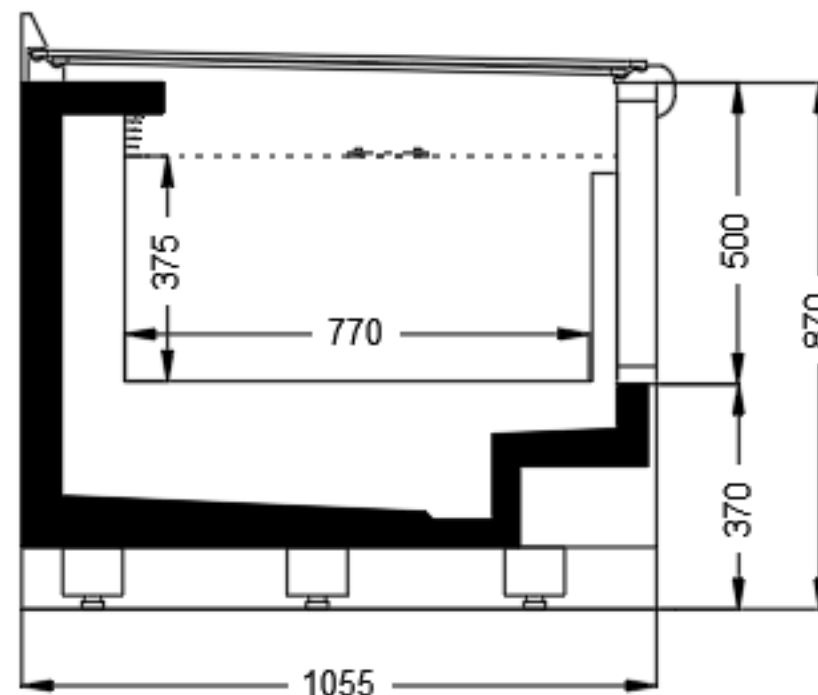



STANDARD FEATURES

- Climate Class: 3L1
- 304 Quality : Wet Board
- Energy Saving Electronic Fans
- Push-Back / Sliding Doors
- Thermostat : Automatic Evaporation
- Refrigerant : R444 & R449 & R744
- Double Evaporator
- Double Thermostat

OPTIONAL FEATURES

- Bumper
- Wire Divider

CROSS SECTION :

Combi 83.A1.SGD

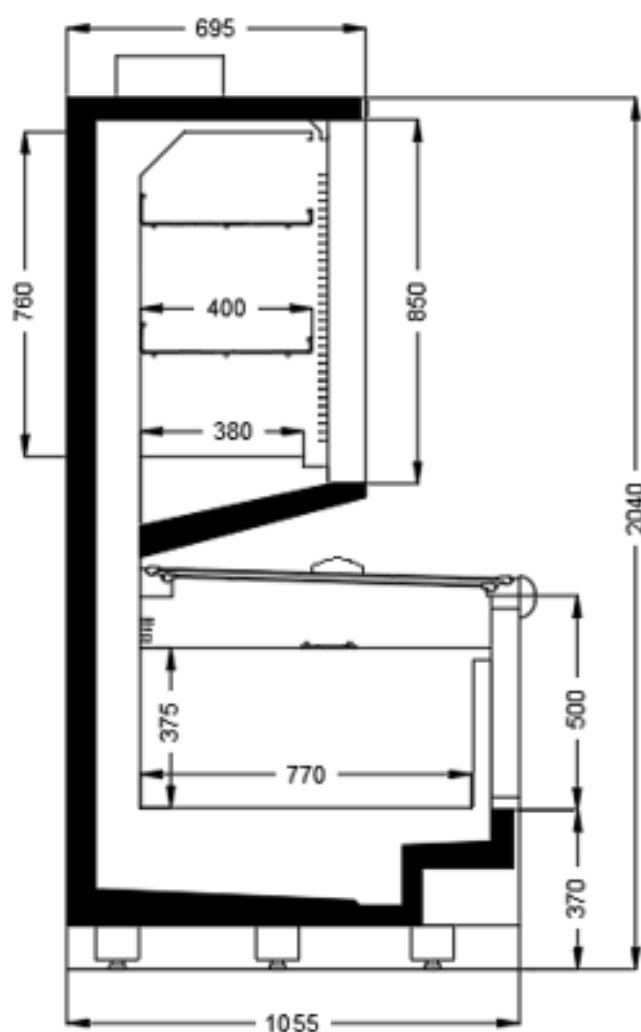

Combi 83.A1.L.SGD

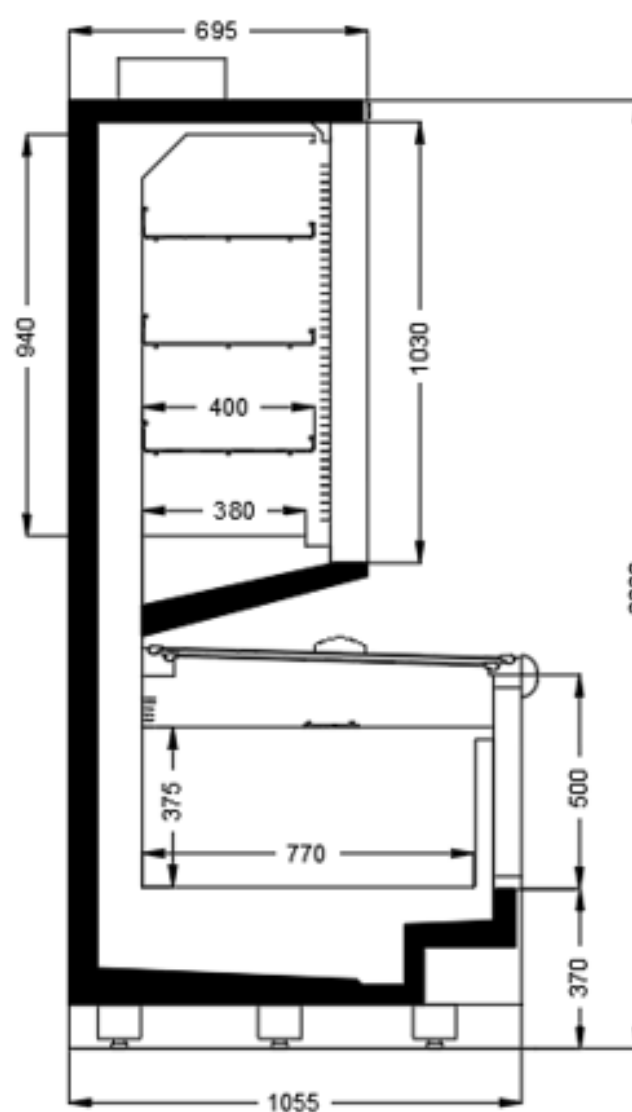

YETKİLİ SATICI



Adress:Köseler Mah. Şükürtepe
Sk No: 90 Dilovası /KOCAELİ
Tel. : 0 262 653 00 33
Faks: 0 262 653 00 31
info@inancteknik.com.tr



www.inancteknik.com.tr

